



9911 9913

Service Manual

Courtesy of:-

G4ILN

And

Racal_Dana user group



[Click to join Racal_Dana](#)

Please enjoy responsibly ☺

G0RSQ
11/2/12

Maintenance manual

9911 & 9913

VHF Frequency Meters

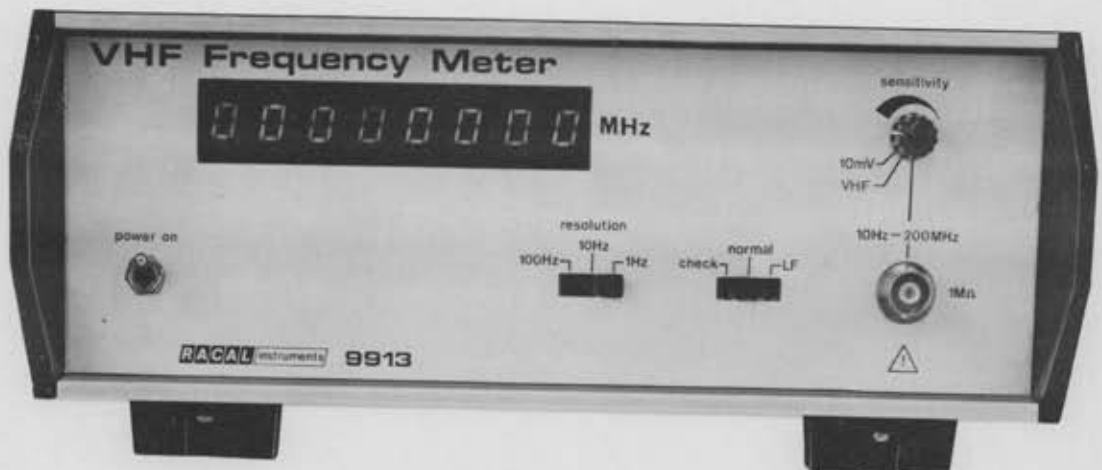
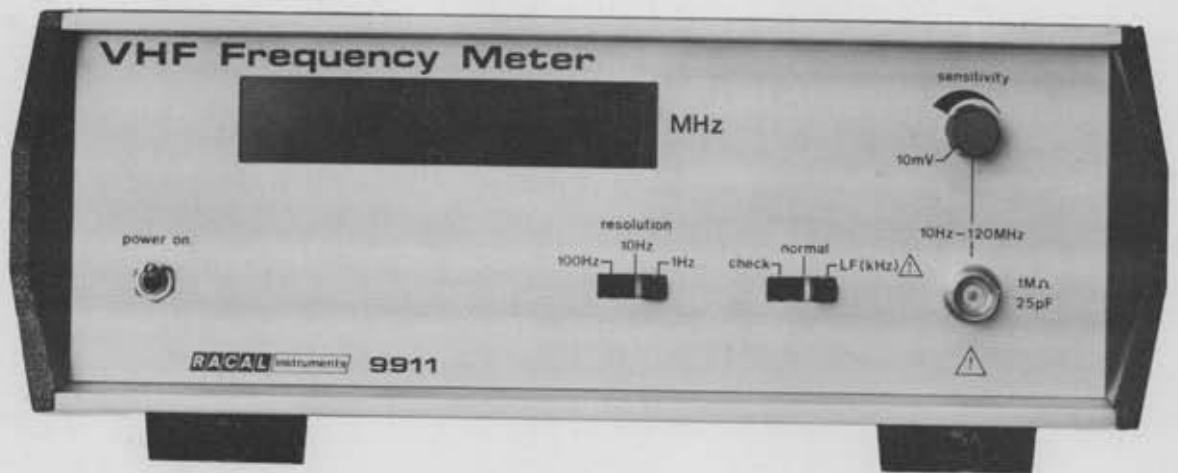

WOH 6127

VHF Frequency Meters 9911 and 9913

HANDBOOK AMENDMENTS

Amendments to this handbook (if any), which are on coloured paper for ease of identification, will be found at the rear of the book. The action called for by the amendments should be carried out by hand as soon as possible.

'POZIDRIV' SCREWDRIVERS

Metric thread cross-head screws fitted to Racal equipment are of the 'Pozidriv' type. Phillips type and 'Pozidriv' type screwdrivers are not interchangeable, and the use of the wrong screwdriver will cause damage. POZIDRIV is a registered trade mark of G.K.N. Screws and Fasteners Limited. The 'Pozidriv' screwdrivers are manufactured by Stanley Tools Limited.

CONTENTS

	<u>Page</u>
FRONTISPIECE	
SECTION 1 TECHNICAL SPECIFICATION AND SUPPLEMENTARY DATA	
SECTION 2 DESCRIPTION OPERATION AND MAINTENANCE	
CHAPTER 1 GENERAL DESCRIPTION	1-1
CHAPTER 2 OPERATING INSTRUCTIONS	
Initial Settings	2-1
Frequency Measurement (Normal Range)	2-1
Frequency Measurement (LF Multiplier Option)	2-2
Description of Controls and Connections	2-2
Front Panel	2-2
Rear Panel	2-3
CHAPTER 3 PRINCIPLES OF OPERATION	
The CDI Chip	3-1
General Circuit Functions	3-2
Dynamic Display System	3-2
Multiplex Readout	3-2
Control Code Information	3-3
Self Check	3-4
Resistor Arrays	3-4
Internal Control Sequence	3-5
External Hold	3-5
CHAPTER 4 TECHNICAL DESCRIPTION	
Logic Circuit Symbols	4-2
Unused Components	4-2
Input Amplifier	4-2
Shaper	4-2
Counter Input Clamp	4-3
Signal Steering (9911)	4-3
Function of IC3a (9911)	4-3
Signal Absent Condition (9911)	4-4
Signal Present Condition (9911)	4-4
Shaper Outputs (9913)	4-4
VHF (Prescaled) Signal Path (9913)	4-4
Normal (Non-Prescaled) Signal Path (9913)	4-4

CHAPTER 4 (Cont'd)

	<u>Page</u>
Summary of Signal Gating	4-5
VHF Mode Selection (9913)	4-6
LF Signal Routing	4-6
Gate Time Extension on VHF	4-6
Function of IC4a and IC4b (9913)	4-6
Check Mode	4-7
Frequency Standard	4-8
Standard Oscillator Assembly (19-0834)	4-8
Optional Oscillator	4-8
Frequency Doubler (9913)	4-8
Internal Standard Output	4-8
External Standard Output	4-8
Data Output and Display System	4-9
Multiplex Readout and Display	4-9
Decimal Point Selection	4-10
Display Blanking	4-11
Power Supply	4-11
+5V Stabilization	4-11
-5V Stabilization	4-11
On/Off Switching	4-12
CDI Chip 2V Supply	4-12
LF Multiplier Assembly (Option)	4-12

CHAPTER 5

MAINTENANCE

Test Equipment Required	5-1
Removal of Covers	5-2
Transformer Voltage Selection	5-2
Fuses	5-4
Power Lead	5-4
Power Supply Check	5-4
Performance Tests and Calibration	5-4
Segment, Decimal Point and Self Check	5-4
Sensitivity Check	5-5
VHF Sensitivity Check (9913 Only)	5-6
LF Multiplier Check (Option)	5-7
Frequency Standard Calibration	5-8
Fitting Optional Frequency Standard	5-9
Fitting LF Multiplier Assembly (Option)	5-10
Dismantling	5-10
Removal of Display PCB	5-10
Removal of Main PCB	5-11
Replacement of Main PCB	5-11

IN TEXT ILLUSTRATIONS

<u>Fig. No.</u>		<u>Page</u>
A1	Data Sequence Diagram	Tech. Spec. (7)
3.1	Basic Frequency Meter	3-1
3.2	Multiplex Display System	3-3
3.3	D.I.L. Resistor Array	3-4
3.4	Control Sequence Diagram	3-5
5.1	Mains Voltage Selection	5-3

LIST OF TABLES

<u>Table No.</u>	<u>Title</u>	<u>Page</u>
1	Data Output Connector	Tech. Spec. (5)
2	Time Base Control Coding	Tech. Spec. (6)
3	Differences Between 9911 and 9913	4-1
4	Summary of Signal Gating	4-5
5	Test Equipment Required	5-1
6	Decimal Point and Self Check	5-5
7	Sensitivity Check: Normal Range	5-6
8	Sensitivity Check: 9913 VHF Range	5-7

SECTION 3 PARTS LISTS, COMPONENT LAYOUTS AND CIRCUIT DIAGRAMS

Component Layout: Display Assemblies (9911 and 9913) Parts List 1: Display Assemblies	Fig. 1
Circuit and Layout: Oscillator PCB Assembly Parts List 2: Oscillator PCB Assembly	Fig. 2
Parts List 3: Chassis, Front and Rear Panel Assemblies	
Parts List 4a and 4b: Main PCB Assembly (9911) Component Layout: Main PCB Assembly (9911)	Fig. 3
Overall Circuit: 9911	Fig. 4
Parts List 5a and 5b (9913) Component Layout: Main PCB Assembly (9913) Overall Circuit: 9913	Fig. 5 Fig. 6

Parts List 7: LF Multiplier (Option)
Circuit and Layout: LF Multiplier Assembly

Fig. 7

SECTION 4 APPENDICES AND CHANGE INFORMATION

SECTION 1

TECHNICAL SPECIFICATION

TECHNICAL SPECIFICATION

DISPLAY

Format:	9911 Seven digit in line LED 7 segment display. 9913 Eight digit in line LED 7 segment display.
Latch:	Previous measurement is displayed during period required to complete new measurement. Display is automatically up dated at end of each measurement.
Reset:	Automatic.
Display Time:	Approximately equal to gate time plus 1 ms.
Self Check:	Reads 1 MHz.

INPUT

Frequency Range:	9911 10 Hz to 120 MHz. 9913 10 Hz to 200 MHz.
Sensitivity:	9911 Better than 10 mV. 9913 Better than 10 mV to 150 MHz, 50 mV to 200 MHz.
Input Impedance:	1 M Ω in parallel with 25 pF.
Level:	Adjustable by front panel potentiometer.
Damage Overload Levels:	250V r.m.s. up to 10 kHz. 50V r.m.s. up to 100 kHz. 10V r.m.s. above 100 kHz. 400V d.c.

FREQUENCY MEASUREMENT

Range:	9911 10 Hz to 120 MHz (prescaled by 2). 9913 HF 10 Hz to 30 MHz (directly gated). VHF 10 MHz to 200 MHz (prescaled by 4).
--------	---------------------------------------------------------------------------------------------------------------------------------

FREQUENCY MEASUREMENT (Cont'd.)

Accuracy:	±1 count ± frequency standard accuracy.
Gate Times:	9911 20 ms, 200 ms and 2s. 9913 HF 10 ms, 100 ms and 1s. VHF 40 ms, 400 ms and 4s.
Resolution:	100 Hz, 10 Hz and 1 Hz.
LF Multiplier:	See Option 09.

FREQUENCY STANDARD

Frequency:	5 MHz.
Ageing Rate:	±1 part in 10^6 per month.
Temperature Stability:	±8 parts in 10^6 over temperature range 0°C to +55°C. ±3 parts in 10^6 over temperature range +20°C to +40°C.
Alternative Timebases:	See Options 04A and 04B.

STANDARD FREQUENCY OUTPUT

Frequency:	9911 500 kHz (via data output connector). 9913 1 MHz (via rear panel BNC socket).
Level:	Standard TTL output.
Waveform:	Approximately rectangular.

EXTERNAL STANDARD INPUT

Frequency:	1 MHz.
Minimum Level:	100 mV r.m.s. into 1 kΩ.
Maximum Level:	10V r.m.s. 400V d.c.
Input Impedance:	Approximately 200Ω (a.c. coupled).

DATA OUTPUTS

Display:	Serial BCD output is provided at standard TTL logic levels giving 8 digits and decimal points.
Function and Control:	Static timebase and overflow outputs with timing controls are provided. (See page (5) Table 1).
Outputs:	Optional accessories are available to give data output in parallel format (for printers etc.) or IEC/ASCII bus compatible format.

POWER REQUIREMENTS

Supply:	94V to 265V r.m.s., 45 to 450 Hz, a.c.								
Voltage Ranges:	Eight ranges selected by transformer connection and link: - <table><tr><td>94V to 106V</td><td>200V to 225V</td></tr><tr><td>106V to 119V</td><td>212V to 239V</td></tr><tr><td>118V to 132V</td><td>223V to 251V</td></tr><tr><td>188V to 212V</td><td>235V to 265V</td></tr></table>	94V to 106V	200V to 225V	106V to 119V	212V to 239V	118V to 132V	223V to 251V	188V to 212V	235V to 265V
94V to 106V	200V to 225V								
106V to 119V	212V to 239V								
118V to 132V	223V to 251V								
188V to 212V	235V to 265V								
Consumption:	17 VA approximately.								

ENVIRONMENTAL AND SAFETY SPECIFICATION

Operating Temperature:	0°C to +55°C.
Storage Temperature:	-40°C to +70°C.
Humidity:	95% r.h. at +40°C.
Mechanical:	In accordance with IEC 68.
Safety:	Meets IEC 348 (BS 4743).

MECHANICAL

Dimensions:	Height: 96.6 mm
	Width: 240 mm
	Depth: 268 mm
Weight:	Approximately 2 kg.

MECHANICAL (Cont'd.)

Accessories Supplied: Operators Manual, Spare Fuses and Supply Voltage Label.

OPTION 04A FREQUENCY STANDARD 9442

Frequency: 5 MHz.

Ageing Rate: ± 3 parts in 10^9 /day after 3 months continuous operation.

Warm-Up Time: Better than ± 2 part in 10^7 within 6 minutes.

Temperature Stability: Better than ± 3 parts in 10^9 per $^{\circ}\text{C}$ over the range -10°C to $+45^{\circ}\text{C}$.

OPTION 04B FREQUENCY STANDARD 9421

Frequency: 5 MHz.

Ageing Rate: ± 5 parts in 10^{10} per day after 3 months continuous operation.

Warm-Up Time: Better than ± 1 part in 10^7 within 20 minutes.

Temperature Stability: Better than ± 6 parts in 10^{10} per $^{\circ}\text{C}$ over the range -10°C to $+45^{\circ}\text{C}$.

OPTION 09 LF FREQUENCY MULTIPLIER

Function: To increase measurement resolution at low frequencies.

Frequency Range: 10 Hz to 5 kHz.

Multiplication: $\times 100$

Sensitivity: 10 mV.

Resolution: 0.01 Hz on longest gate time.

SUPPLEMENTARY DATA

DATA OUTPUT CONNECTIONS

A1. Data and Command information is available via a 28-way edge connector accessible by removing a cover on the rear panel. The facilities and pin connections are listed in Table 1 below. The logic for time base data is given in Table 2 overleaf.

TABLE 1
Data Output Connector

Pin	Facility	Pin	Facility
1	-5.2V	A	0V
2	+5V	B	Not used
3	Key way	C	Key way
4	$\bar{4}$ (BCD) 9911 <u>overflow</u>	D	$\bar{1}$ (BCD)
5	$\bar{8}$ (BCD) 9913 <u>overflow</u>	E	$\bar{2}$ (BCD)
6	<u>External Hold</u> Input	F	See NOTE 1
7	Not used	H	<u>Main Gate</u>
8	Not used	J	See NOTE 2
9	\bar{c}) Function	K	\bar{z}) Time Base
10	\bar{b}) Information	L	\bar{y}) Information
11	\bar{a}) (logic '1')	M	\bar{x}) See Table 2
12	\bar{R}_0	N	Not used
13	Not used	P	Not used
14	<u>Prescale</u> (9913 only)	R	Not used

- NOTES:
1. Pin F output is the display synchronising signal, which is 5 kHz in the 9911 and 10 kHz in the 9913.
 2. Pin J output is a 500 kHz frequency standard reference output in the 9911 and a 1 MHz reference output in the 9913.
 3. External Hold If, when used with external circuitry, it is required to extend the cycle time, the external hold, (logic '0', pin 6) must be applied within the gate time or up to 100 μ s after gate closure. In order to initiate a new cycle of measurement the external hold must go 'high' for not less than 200 μ s.

TIME BASE CONTROL LOGIC

A2. The function and time base requirements are applied internally to the CDI Chip on a six-line code. The inverse states of this code are fed out to the rear Data Output connector. As the 9911 and 9913 are single function instruments the \bar{a} , \bar{b} , \bar{c} 'function' lines are held permanently at logic '1'. The time base coding is given in Table 2.

TABLE 2
Time Base Control Coding

Code			Gate Times		
\bar{x}	\bar{y}	\bar{z}	9911	9913 (HF)	9913 (VHF)
0	1	1	20 ms	10 ms	40 ms
1	0	1	200 ms	100 ms	400 ms
0	0	1	2s	1s	4s

NOTE: When the optional LF multiplier facility is selected the resolution is increased by a factor of 100 times.

DATA OUTPUT FORMAT

A3. The b.c.d. output data is available at the 28-way edge connector in a bit parallel byte serial form. The data is sequenced by a 5 kHz synchronising signal in the 9911 and a 10 kHz signal in the 9913. The data presentation is delayed 0.5 μ s from the negative edge of the synchronising signal. An additional synchronising pulse (R_0) determines the first state (10^0 digit). See Fig. A1 on the following page.

A4. There are ten output states, as follows:-

<u>States</u>	<u>Facility</u>
1 to 8	Digit (display) information. Overflow for 10^3 , 10^4 , 10^6 and 10^7 digits on pins D, E, 4 and 5 respectively.
9	
10	Decimal point position in kHz units, plus overflow information for 10^5 digit, via pin 5.

Timing Diagram

A5. Fig. A1 shows the timing sequence for the ten states in the 9913. The 9911 is similar except that the synchronising signal and R_o timings are doubled. The diagram is not drawn to scale.

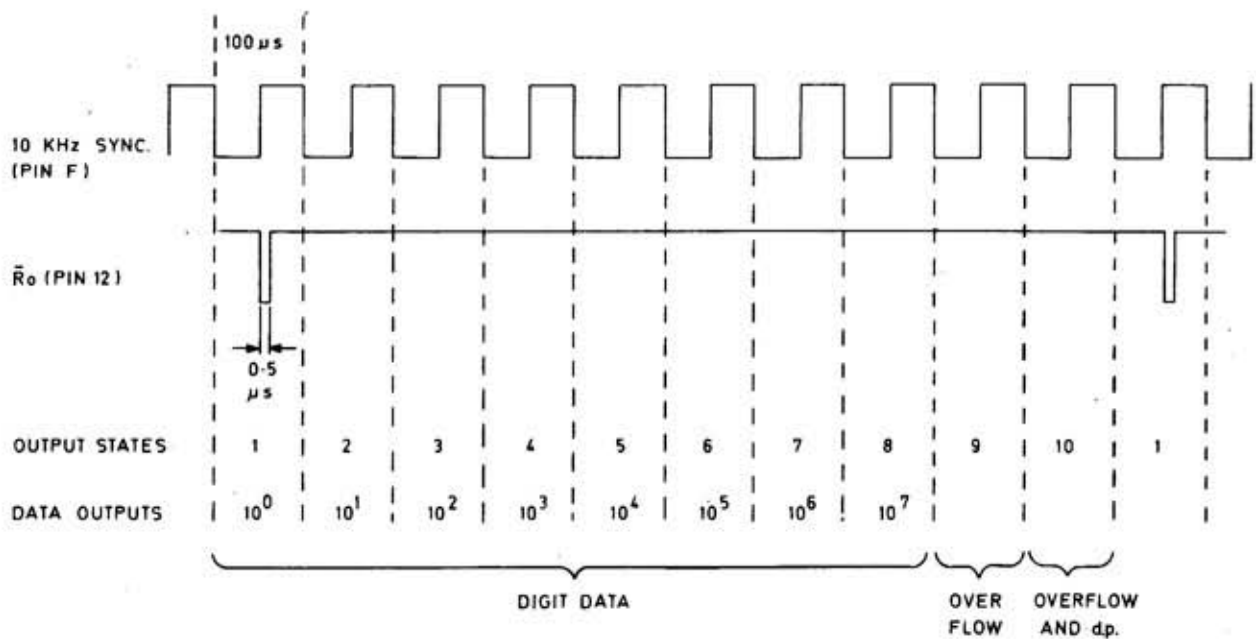

Data Sequence Diagram

Fig A.1

SECTION 2

DESCRIPTION

OPERATION & MAINTENANCE

CHAPTER 1

GENERAL DESCRIPTION

INTRODUCTION

1.1 The V. H. F. Frequency Meters 9911 and 9913 are compact lightweight instruments providing convenient, accurate and economic measurement. The two types are identical in basic design and construction but with technical differences which are summarized in Table 3 on page 4-1. The operational differences are in frequency range and display, as follows:-

9911: The frequency range is 10 Hz to 120 MHz. Inputs are prescaled by a factor of two and the measurements displayed on a seven digit readout.

9913: Frequency coverage is 10 Hz to 200 MHz in two ranges. The basic (HF) range is 10 Hz to 30 MHz with direct gating. The VHF range is 10 MHz to 200 MHz, prescaled by 4. Measurements are displayed on an eight digit readout.

1.2 An optional LF Multiplier facility enables both instruments to measure low frequencies, using a technique which multiplies the input signal frequency by 100.

1.3 Three gate times are available, the switch positions are marked in the resolution provided. The latched display employs seven-segment light-emitting diode (LED) indicators, with automatic positioning of the decimal point.

FREQUENCY STANDARD

1.4 A discrete component 5 MHz oscillator is fitted in the basic versions of both instruments, but at customer's option a high stability fast-warm-up oscillator from the Racal range may be fitted. This precision unit should be serviced only by Racal Instruments or authorized agent. An aperture in the rear panel provides access for calibration of the oscillator.

1.5 A rear panel socket permits the use of an external frequency standard input. Also available is a reference signal output, derived from the frequency standard in use. This reference output is available via the Data Output socket on the 9911, and via a BNC socket on the 9913.

POWER SUPPLY

1.6 The instruments operate from a.c. supplies of 94V to 132V and 188V to 265V, 45 to 450 Hz. The correct tapping must be made on the internal mains transformer to conform with the local a.c. supply voltage. (See page 5-2).

DATA OUTPUT

1.7 Details of the data output format and the facilities at the 28-way rear panel connector are given in the supplement to the Technical Specification at the front of the book.

CHAPTER 2

OPERATING INSTRUCTIONS

INTRODUCTION

2.1 Before using the instrument for the first time, or at a new location, check the power supply as described in paragraphs 5.2 to 5.4. The description of controls in this Chapter will assist the user in correct use of the instrument.

INITIAL SETTINGS

- 2.2 (1) Set the POWER switch to ON. If the instrument is fitted with the optional fast-warm-up oscillator the appropriate warm up time should be allowed.
- (2) Set the CHECK/NORMAL/LF switch to NORMAL.

FREQUENCY MEASUREMENT (Normal Range)

- 2.3 (1) Set the variable SENSITIVITY control as follows:-
- (i) 9911: Initially fully clockwise, or as required if input level is known.
- (ii) 9913: For frequencies in the range 30 MHz to 200 MHz set the SENSITIVITY control to the VHF (switched) position. In this position the sensitivity is fixed. The VHF range may be used from 10 MHz upwards if preferred.
- (2) Connect the external signal to the input socket (high impedance). The maximum and minimum input levels are as follows:-
- | <u>Maximum</u> | <u>Minimum</u> |
|--------------------------|------------------------------|
| 250V r.m.s. up to 10 kHz | 10 mV up to 120 MHz (9911) |
| 50V r.m.s. up to 100 kHz | 10 mV up to 150 MHz } (9913) |
| 10V r.m.s. above 100 kHz | 50 mV above 150 MHz } |
- (3) If not switched to VHF, the variable SENSITIVITY control may be adjusted as required for the signal conditions. The most sensitive condition is anti-clockwise as indicated by the '10 mV' marking. The variable range of the control can be adjusted to provide useful filtering of h.f. interference when measuring lower frequencies.

- (4) Set the RESOLUTION switch as required. Generally this switch should be set to a position which allows the measurement to just fill the display. The readout is in MHz.

FREQUENCY MEASUREMENT (LF MULTIPLIER OPTION)

- 2.4 (1) Set the SENSITIVITY control fully clockwise.
- (2) Set the CHECK/NORMAL/LF switch to LF (kHz).
- (3) Connect the external signal to the input socket (high impedance).
- (4) Set the RESOLUTION switch as required. Note that the selected resolution is multiplied by 100 by the LF facility.
- (5) Adjust the SENSITIVITY control, anticlockwise until steady counting is obtained. The readout is in kHz.

NOTE: When no input signal is applied it is normal for the instrument to show a few counts.

DESCRIPTION OF CONTROLS AND CONNECTIONS

2.5 FRONT PANEL

POWER ON/OFF Switch:	A single pole switch which switches the internal d.c. supply.
RESOLUTION Switch:	This 3-position switch selects the required timing signal from the time base to give the required gate time. Generally, the switch will be set so that the measurement just fills the display. The resolution is indicated by the switch marking.
CHECK/NORMAL/ LF Switch:	In the CHECK position a reference signal derived from the frequency standard is fed to the counter-display circuits to provide a 1 MHz readout. The NORMAL position is for operational use, giving a readout in MHz. The LF position is an optional facility for measurement of very low frequencies, giving a readout in kHz.
SENSITIVITY (variable control):	This is a potentiometer providing manual variation of sensitivity in the input amplifier. The most sensitive condition is fully anti-clockwise (10 mV position).

9913 Only. In the 9913, the SENSITIVITY control has a switched position marked 'VHF'. In this position the input signal is prescaled by a factor of 4, thus providing a measurement range of 10 MHz to 200 MHz with fixed sensitivity.

Input Socket:

The signal to be measured is connected to the high impedance BNC socket on the front panel.

2.6 REAR PANEL ITEMS

POWER Connections:

The power cable is attached to the instrument.

POWER FUSE:

A 5 x 20 mm cartridge-type anti-surge fuse must be fitted. Correct fuse ratings are marked on the rear panel.

EXT. STD. INPUT
Socket:

This BNC socket accepts a 1 MHz external frequency standard. The instrument will automatically inhibit the internal oscillator signal

OSC. ADJUST
(See NOTE):

This aperture provides access to the mechanical frequency adjustment in the frequency standard oscillator. Calibration must be carried out in accordance with instructions in Chapter 5.

DATA OUTPUT
Connector:

A 28-way edge connector is accessible at the rear panel. The connection details are listed in the supplement to the Technical Specification.

Internal Standard
Output:

In the 9911 a 500 kHz reference signal is available at the Data Output connector.

In the 9913 a 1 MHz reference signal is available at the Data Output connector and also via a BNC socket on the rear panel.

NOTE:

In early models the standard oscillator is mounted on the main p.c.b., in which case this aperture is for use only when the optional frequency standard unit is fitted. In later models both standard and optional oscillators can be adjusted via this aperture.

CHAPTER 3

PRINCIPLES OF OPERATION

THE CDI CHIP

3.1 A basic digital frequency meter comprises a chain of decade counters feeding b.c.d. data into latched stores. Counting is controlled via a main gate which is opened for a period determined by the time base. Provision is made for resetting the counter and releasing the data for display. In the 9911 and 9913 these functions are carried out in the integrated circuit IC6, which achieves large scale integration, using the collector-diffusion-isolation principle. For convenience, IC6 will often be referred to in the handbook as the 'CDI Chip'.

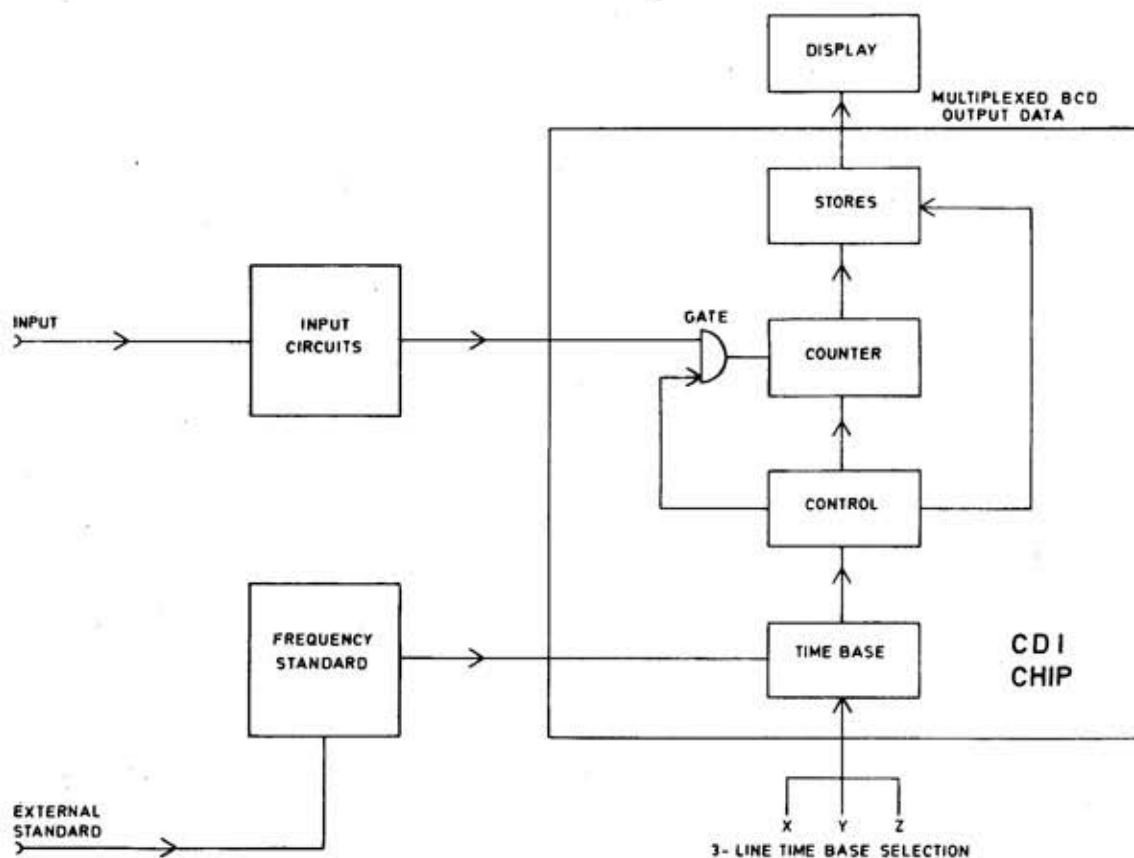

Basic Frequency Meter

Fig. 3.1

GENERAL CIRCUIT FUNCTIONS

- 3.2 Outside the CDI Chip, other circuit functions are carried out, such as:-
- (a) Input amplification and signal shaping. Sensitivity control and input signal selection. Check signal routing.
 - (b) An LED digit display system operates in bit-parallel byte serial (multiplex) form, with data readout available for external use, and automatic decimal point positioning.
 - (c) Clock (reference) frequency generation using a discrete 5 MHz oscillator circuit, or an optional high-stability temperature controlled oscillator. The reference frequency is doubled to 10 MHz for use in the CDI Chip in the 9913.
 - (d) The power system operates from a.c. mains feeding +5V and -5V rectifiers and stabilizing circuits and +2V supply to the CDI Chip.

DYNAMIC DISPLAY SYSTEM

3.3 The display uses light-emitting diodes as numerical indicators. These indicators are driven by b.c.d. data from the CDI Chip, via a seven-segment decoder. Each displayed numeral is formed by illuminating an appropriate number of short straight segments. The numeral '8', for example, is formed from 7 segments, whereas the numeral '6' will require only 5 segments.

MULTIPLEX READOUT

- 3.4 The readout data is fed from the CDI Chip to the display via a single four-wire b.c.d. connection. To permit this simple interconnection a parallel-to-serial (multiplex) system is used. The principles are shown in Figure 3.2, although it should be noted that part of the system is in the CDI Chip.
- 3.5 In the CDI Chip the data stores feed in parallel into a common b.c.d. four-line output. The store outputs are enabled in turn for approximately 100 μ s by a 10 kHz reference signal (9913) or 200 μ s (5 kHz) in the 9911.
- 3.6 The b.c.d. data is fed via a 7-segment decoder (IC19) to the Display Assembly which offers the decoded data to the bank of LED digital indicators. The 10 kHz (or 5 kHz) reference signal is fed to a BCD/Decimal decoder which enables each display LED in turn. A reset pulse (Ro) which is generated in the 10⁰ state of the counter, ensures that the display enable is synchronised with the data store readout.

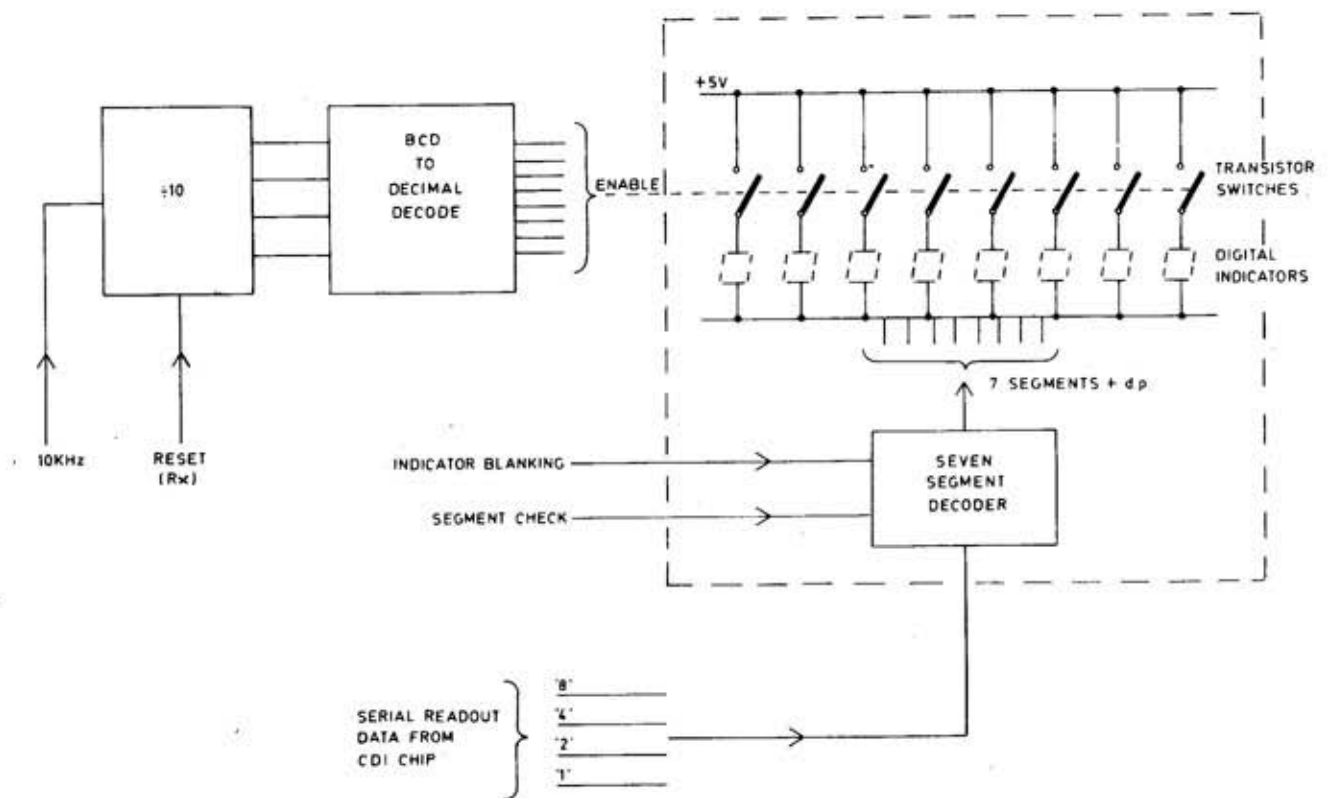

Multiplex Display System

Fig. 3.2

Decimal Point

3.7 Decimal point (d.p.) illumination is obtained by encoding the time base control (RESOLUTION) switch logic with the digital indicator enable signals. When operating in the optional LF mode the decimal point encoding is automatically shifted to provide a readout in kHz.

CONTROL CODE INFORMATION

3.8 A 3-line system is used for time base (gate time) selection. The lines are identified as x, y and z, and the logic coding is in Table 2 in the Technical Specification.

SELF CHECK

- 3.9 In the Self Check mode a reference frequency takes the place of the unknown frequency, thus providing a check on the measurement system.

Resistor Arrays

- 3.10 Many of the integrated circuits are 'open collector' types. For these IC's discrete 'pull-up' resistors are provided in the circuit. These resistors may be mounted in sealed dual-in-line (d.i.l.) packages, for example R91 which has seven 56Ω resistors with a common connection to +5V. Such arrays cannot be serviced and must be changed in the event of a faulty resistor. Figure 3.3 shows a typical array schematically.

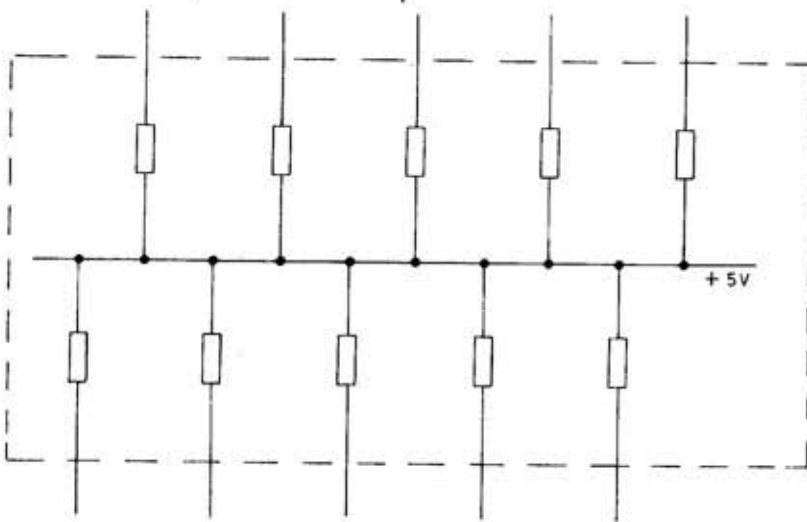

D.I.L. Resistor Array

Fig. 3.3

INTERNAL CONTROL SEQUENCE

3.11 Fig. 3.4 shows the control sequence diagrammatically, not to scale.

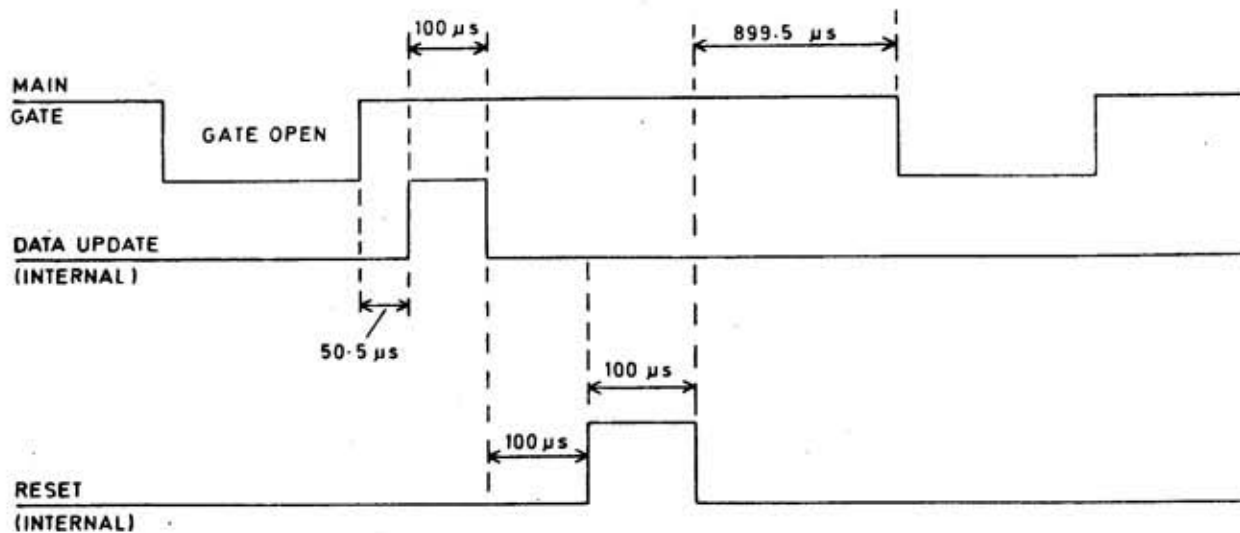

Control Sequence Diagram

Fig.3-4

External Hold

3.12 If, when used with external circuitry, it is required to extend the cycle time, the external hold, (logic '0', pin 6) must be applied within the gate time or up to 100 μs after gate closure. In order to initiate a new cycle of measurement the external hold must go 'high' for not less than 200 μs.

CHAPTER 4

TECHNICAL DESCRIPTION

INTRODUCTION

4.1 Apart from some switches and certain items of the power supply, the circuit for each instrument is mounted on one main p.c.b. assembly, with smaller assemblies for the display, reference oscillator and LF Multiplier Option. The main technical differences are summarized in Table 3.

TABLE 3
Differences Between 9911 and 9913

Facility	9911	9913
Display	Seven digit.	Eight digit.
Frequency range	10 Hz to 120 MHz. Signal prescaled by 2.	NORMAL range (10 Hz to 30 MHz) directly gated. VHF range (10 MHz to 200 MHz) prescaled by 4 and gate time extended.
Gate times	Multiples of 20 ms	Multiples of 10 ms (NORMAL) or 40 ms (VHF)
Reference frequency	5 MHz into CDI Chip. 500 kHz output from CDI Chip for self check.	10 MHz into CDI Chip. 1 MHz output from CDI Chip for self check.
External frequency standard input	1 MHz input, divided by 2 within the CDI Chip.	1 MHz input.
Internal standard output	500 kHz at rear data connector.	1 MHz at rear data connector and at BNC rear panel socket.
Multiplex synchronising frequency	5 kHz (200 μ s)	10 kHz (100 μ s)
Sensitivity control	Variable	Variable on NORMAL. Fixed on VHF.

LOGIC CIRCUIT SYMBOLS

4.2 Extensive use is made of integrated circuits (IC's) and these are identified by a number and suffix letter. In the circuit description a particular IC pin will be identified by a reference such as 'IC10a/3', which indicates pin 3 on that particular gate. The logic symbols used in the circuits are those found in most manufacturers IC data sheets to which reference should be made if detailed information is required. The CDI Chip IC6 is, however, obtainable only through the Service Department of Racal Instruments Ltd.

UNUSED COMPONENTS

4.3 The 9911 and 9913 are closely related members of a family of instruments. For this reason the circuit of the 9911 contains a few IC stages which are retained but not used.

CIRCUIT DESCRIPTIONS

4.4 Paragraphs which apply only to a particular instrument are headed '9911' or '9913'. The remainder of the Chapter applies to both instruments with any differences being mentioned where appropriate.

INPUT SIGNAL PATH

Input Amplifier

4.5 The input circuit as far as the shaper IC12a is the same design in both instruments. The external signal is fed from the front panel BNC socket via capacitor C50 to the SENSITIVITY potentiometer 1R1 which is mounted on the display p.c.b. From 1R1 the signal is fed via clipping resistor R50 and bypass capacitor C51 to the main p.c.b. at pin 15. In the 9913 the SENSITIVITY control has an associated switch (1S3) which is used to select the VHF range as described in para. 4.18.

4.6 The amplifier has a high impedance FET input (Q1) with further protection by resistor R1 together with the gate-drain junction and diode D1. The output from Q1 source is fed to a shunt-feedback stage Q2 whose gain is determined by R5 and R7.

4.7 From Q2 the signal is fed to the differential pair Q3/Q4 and these drive a further differential pair Q5/Q6. From Q6 collector the signal is fed via amplifier Q7 to the shaper IC12a. From the collector of Q7 the signal is also fed, via R58, to the LF Multiplier p.c.b. (if fitted).

Shaper

4.8 The shaper IC12a is a line receiver which is arranged to operate as a Schmitt trigger by the feedback circuit to pin 4. From this point the 9911 and 9913 employ different signal paths. Table 4 summarizes the signal gating arrangements for both instruments. Users of the 9913 should continue the description at para. 4.14.

Counter Input Clamp

4.9 The signal path from level-shifting stage Q9 to the input of the CDI Chip is entirely d.c. coupled. It is therefore essential that, in the absence of a signal, the counter input at IC6/22 be held down to a '0', otherwise a false +1 count will occur. It is the function of IC3a (9911) to ensure that this '0' level is maintained in the absence of a signal. In the 9913 the same function is performed by IC4a.

Signal Steering (9911)

4.10 Reference should be made to the 9911 circuit diagram (Fig. 4, at the back of the book). From the shaper IC12a/3 the signal in the 9911 is fed to a divide-by-two bistable at IC9/6. The divided output from IC9 is level-shifted to TTL levels in Q9/Q10 and then fed from the collector of Q9 through the steering gates IC8a/1, IC8b/4, IC8d/12 and IC8c/10 to the counter input of the CDI Chip (IC6/22).

Function of IC3a (9911)

4.11 The basic purpose is described in para. 4.9, the circuit action is as follows. IC3a is a D-type bistable using the main gate waveform as the CLK and the input signal line condition as the Preset. Two conditions must be considered, signal absent and signal present.

4.12 Signal Absent Conditions (9911)

- (1) The input level applied to the Preset (IC3a/4) could be either '1' or '0'. If it is '0' the 'Q' output at IC3a/5 will be at '1' and this will produce a '0' at IC8c/8 as required.
- (2) If the input level at IC3a/4 is at '1', the positive closure edge of the main gate waveform, applied to IC3a/3, will clock the '0' on the 'D' terminal to the 'Q' output at IC3a/5, thus producing a '0' at IC8c/8 as required.

4.13 Signal Present Conditions (9911)

- (1) The incoming signal via IC8b/6 will be alternating between '0' and '1'.
- (2) When the incoming signal is '0' the preset of IC3a will send the 'Q' output to '1', thus opening the gate IC8d and allowing the signal to pass via IC8d/12 and IC8c to the counter.

Shaper Outputs (9913)

4.14 This description is a continuation from para. 4.8. Reference should be made to the circuit diagram Fig. 6. One output from shaper IC12a/2 is fed to a divide-by-four stage IC13 for prescaling of the v.h.f. signal. The other output, from IC12a/3, is fed to the line receiver amplifier IC12b, which is operative when VHF mode is not selected.

VHF (Prescaled) Signal Path (9913)

4.15 The signal from shaper IC12a/2 is divided by four in IC13 and fed via line receiver amplifier IC12c to the level-shifting stage Q9/Q10, which feeds the signal at TTL levels to the VHF/NORMAL selection gate at IC8a/1. From IC8a the signal is fed through the common signal path via IC8b/6, IC8d/12 and IC8c/10 to the counter input at IC6/22.

Normal (Non-Prescaled) Signal Path (9913)

4.16 The shaped signal from IC12a/3 is fed to the line receiver amplifier at IC12b/9. This amplifier is operative when the SENSITIVITY control TR1 is in a variable position (i.e. the control is not switched to 'VHF').

4.17 From IC12b the push-pull output is fed to Q8 and Q31. From the collector of Q8 the signal is fed to the common signal gate IC8b, thence along the common signal path IC8b/6, IC8d/12 and IC8c to the counter input at IC6/22.

VHF Mode Selection (9913)

4.18 The VHF/NORMAL selection gate IC8a is enabled by a '1' from R53 when the SENSITIVITY control switch 1S3 is set to VHF (provided the CHECK/NORMAL/LF switch is not at CHECK or LF). By setting switch 1S3 to VHF the earth is removed from R53 and transferred to pin 10 of IC12b. This inhibits IC12b, thus cutting off the directly gated signal path. The inhibit also causes Q8 to be turned off, giving a '1' at the collector which enables the gate IC8b/5, thus allowing the VHF (prescaled) signal to pass through.

LF Signal Path

4.19 The input signal to the optional LF Multiplier is from Q7, via R48 and pin 19 of the main p.c.b. The LF Multiplier output returns to the main p.c.b. at pin 20 and is fed via gates IC5d/13 and IC8c/9 to the counter input at IC6/22.

Gate IC5d is enabled by a '1' via R52 when switch 1S1 is at 'LF'. The same logic signal at R52 is also applied to the decimal point decoder IC18/1 to select the decimal point for a readout in kHz units.

GATE TIME EXTENSION ON VHF (9913)

4.20 On VHF mode the input signal is divided by four, therefore the main gate open period is extended by a factor of four to allow a direct reading of the input frequency.

4.21 The gate time extension is achieved by pulling up the Prescale Select pin of the CDI Chip (IC6/21) to logic '1' via R53. This instructs the CDI Chip to introduce an additional divide-by-four stage into the time base chain. When VHF is not selected the switch 1S3 applies an earth to R53 which restores the normal gate time.

TABLE 4
Summary of Signal Gating

Selected Mode	Input to CDI Chip via IC8c	Signal Path	Logic Control
CHECK	Reference signal via IC8c/9	From IC6/6 via:- IC5c/10 IC8c/9	IC5c/9 and R54. IC8d and IC8c/10.
NORMAL	Measurement signals via IC8d/12	From Q9 via:- IC8a/1 IC8b/4 IC8d/12 IC8c/10	IC8a/2 and R53 Permanently enabled via R57 in 9911. In 9913 enabled by Q8 inhibit (VHF) or via IC8a/2 and switch 1S3 (Not VHF). IC8d/13 via IC3a/5 (9911) or IC4a/6 (9913) IC8c/9 enabled by '0' on IC5c/9.
LF (Option)	Multiplied LF signal	From Q7 and LF Multiplier p.c.b. via:- IC5d/13 IC8c/9	IC5d/12 and R52 IC8d/13. Refer to description of IC3a (para. 4.11) or IC4a (para. 4.22).
VHF with NORMAL (9913)	Measurement signals via IC8a (prescaled) or IC12b (direct).	Prescaled path via:- IC8a/1 IC8b/4 IC8d/12 IC8c/10	IC8a/2 and R53. IC8b/5 enabled by R57 and inhibit on Q8. Enabled via IC4a \bar{Q} output. IC8c/9 enabled by '0' on IC5c/9.

FUNCTION OF IC4a and IC4b (9913)

- 4.22 The purpose of this circuit is described in para. 4.9, and the operation is very similar to that of IC3a in the 9911 (see paras. 4.11 to 4.13). The circuit action is as follows.
- 4.23 When the main gate closes, a positive-going edge is produced at IC6/19 and fed to the CLK input at IC4b/11. This produces a '1' at the ' \bar{Q} ' output of IC4b which, via inverter IC5b presets IC4a. Assuming that no input signal is present, this will produce a '0' at IC4a/6 which is applied via IC8d/13 to IC6/22, thus giving the required condition described in para. 4.9.
- 4.24 The purpose of the 1 MHz reference signal applied to IC4b/10 is to convert the triggering edge from the main gate into a 1 μ s pulse suitable for operation of the Preset in IC4a. The 'clear' at IC4b/13 is at '1' except in LF mode. When switch 1S1 is set to 'LF', the Clear goes to '0', which via IC4a/6 applies a '0' to IC8d/13, thus inhibiting the NORMAL and VHF signal path at IC8d/12.
- 4.25 The arrival of an input signal at IC4a/3 clocks the \bar{Q} output of IC4a back to '1', thus removing the clamp from the counter input at IC6/22.

CHECK MODE

4.26 In CHECK mode the reference signal is fed from the CDI Chip (IC6/6) via gates IC5c/10 and IC8c/9 to the counter input (IC6/22). Gate IC5c is enabled when the CHECK/NORMAL/LF switch 1S1 allows R54 to go high. Any external signals are inhibited by switch 1S1, as follows:-

4.27 9911

- (1) R53 is pulled down which applies a '0' to IC8a/2, thus inhibiting the Normal input signal.
- (2) R52 is pulled down which inhibits the LF signal at IC5d.

4.28 9913

- (1) Switch 1S1 allows R54 to go high, applying a '0' (via IC5a/2) to IC8a/2, which inhibits the VHF (prescaled) signal.
- (2) Switch 1S1 applies an earth to IC12b/10, which inhibits the 'Normal' (directly gated) input.

FREQUENCY STANDARD

Standard Oscillator Assembly 19-0834

4.29 In the standard instrument the reference frequency is generated in a 5 MHz discrete component assembly attached to the rear panel with access to the trimming capacitor (C4), via a rear panel aperture. The circuit is shown in the main p.c.b. circuit and also in Fig. 2. In early models the 5 MHz oscillator was mounted on the main p.c.b. and the output connected via link LK14. The circuit is identical to that in 19-0834 but the component references are different. This early circuit (Q13 XL1, C33 etc.) is shown in the 9911 circuit (Fig. 4).

Optional Oscillator

4.30 The optional fast warm up oscillator is mounted in a B7G base and connected as shown in the circuit diagrams (Fig. 4 and Fig. 6). This is a precision item. If a fault develops, users are advised to return the oscillator unit to Racal Instruments Ltd. or approved agent, for servicing. No parts list or circuit information is provided in this handbook. Instructions for fitting an optional oscillator are given in Chapter 5. When fitting a 9421 oscillator check that the link is fitted between pins 5 and 6 on the B7G base.

4.31 The 5 MHz oscillator signal drives the amplifier-shaper Q14. The 5 MHz signal from Q14 is fed direct to the CDI Chip (IC6/5) in the 9911 and via a frequency doubler in the 9913.

Frequency Doubler (9913)

4.32 The 5 MHz reference from the oscillator is fed to the shaper Q14 and the near square wave output is fed via inverter IC2b to the two branches of a digital doubler with output at IC1a/3. By a process which delays the signal in one path by a series of inverters, then by an Exclusive-OR arrangement, the two signal paths produce a doubling effect.

Internal Standard Output

4.33 9911

A 500 kHz reference at pin 6 of the CDI Chip is fed via buffer IC7f to pin J on the Data Output Connector.

4.34 9913

A 1 MHz reference at pin 6 of the CDI Chip is fed via buffer IC7f to pin J of the Data Output Connector and also to a BNC socket on the rear panel.

External Standard Input

- 4.35 In both instruments a 1 MHz reference can be fed in at the rear panel EXT STD INPUT socket. This signal is fed through the amplifier-shaper stage Q11/Q12 and, in the 9913, fed direct to pin 20 on the CDI Chip. In the 9911 the 1 MHz reference is divided by two in the bistable IC3b then fed via the inverter IC11a to pin 20 of the CDI Chip.
- 4.36 It is a feature of both instruments that they automatically change to external standard operation when the external standard signal is connected. This is arranged within the CDI Chip according to the logic level at IC6/20. This level must be '0' for internal standard operation.
- 4.37 In the 9913 the logic is provided via Q12 which is a saturated stage with a '0' at the collector when no external standard is applied. In the 9911 the required logic is provided by the potential divider R108/R109 and inverter IC11a.

DATA OUTPUT AND DISPLAY SYSTEM

NOTE: Refer to the Supplementary Data in the Technical Specification at the front of the book for a summary and diagram of the data output format. In the description below the 10 kHz synchronising signal refers to the 9913.

Multiplex Readout and Display

- 4.38 The Display Assembly contains a readout system using light-emitting diode (LED) numerical indicators. The display data is fed from the CDI Chip on pins 15 to 18, this 4-way output being fed from a parallel-to-serial (multiplex) system within the Chip, to the 7-segment decoder IC19.
- 4.39 In the multiplex system the b.c.d. outputs from the data stores are fed in sequence on to the 4-way output. This is determined by a 10 kHz synchronising signal (derived from the frequency standard) which interrogates each decade store in turn for a period of 100 μ s. The same 10 kHz signal is used (via IC14 pin 14) to enable the appropriate LED in the Display. (In the 9911 the synchronising signal is 5 kHz and the interrogating period is therefore 200 μ s).
- 4.40 The system is set by the (Ro) signal which occurs in the 10^0 state of the data output at IC6/14. This sets IC14 to the '0' state, and via IC17/1, turns on Q17. This enables the 10^0 digital indicator D.I.1, which displays the digit determined by the 7-segment decoder IC19. The other display LED's are then enabled in sequence for a period of 100 μ s each. (200 μ s periods in 9913). See Note 2 on page 4-11 regarding links LK1 & LK2.

Decimal Point Selection

- 4.41 The decimal point (d.p.) in the required display LED is illuminated by turning on the common d.p. cathode driver transistor Q27 at the same time as the anode of the required digit LED is enabled.

4.42 Transistor Q27 is controlled via the gates IC15a, b and c, and the +5V available via R89. Except when a decimal point is required, Q27 will be turned off because one of the gates IC15a, b or c will have an output at '0', thus pulling down R89.

4.43 The decimal point is selected by encoding the states of four digit enable lines from IC17 in the 2-to-1 Multiplexer IC18. The lines from IC17 are always at '1' except when they are receiving the 100 μ s (or 200 μ s) digit enable signal. The output from IC18 is then encoded in gates IC15a/b and c with the logic from the RESOLUTION switch 1S2. This switch provides the following logic:-

<u>Resolution Selected</u>	<u>Logic at IC15</u>
100 Hz	(IC15a/1 = '1' (IC15b/4 = '0' (IC15c/10 = '0'
10 Hz	(IC15a/1 = '0' (IC15b/4 = '0' (IC15c/10 = '1'
1 Hz	(IC15a/1 = '0' (IC15b/4 = '1' (IC15c/10 = '0'

4.44 From the above it can be seen that the outputs from IC15a, b and c will all be at '1', to turn on Q27, when the appropriate line from IC17 falls to '0'.

4.45 The encoder IC18 receives a '1' on IC18a/1 via R52 when the CHECK/NORMAL/LF switch is set to 'LF'. This effectively shifts the d.p. selection so that the resolution is increased by 100 times (readout in kHz).

Display Blanking

4.46 The display is blanked out briefly, whilst the multiplex system is synchronising, by a short duration '0' applied to pin 4 of the seven segment decoder IC19. This signal is obtained from the closure edge of the main gate waveform.

4.47 The main gate waveform at IC6/19 is inverted in IC11d and fed via C50 to the base of Q26. The closure edge is differentiated by R86/C50 which briefly turns off Q26, thus applying a '0' pulse (via inverter IC11c) to IC19/4.

POWER SUPPLY

4.48 The a.c. supply is fed in via a three-core flying lead to the rear panel, thence via the anti-surge fuse FS50 to the transformer T50. The transformer tapplings are arranged to suit the local supply voltage as shown in Chapter 5. The output at secondary winding 'A' is rectified by the diode bridge rectifier D9-D12 and supplies the

+5V regulator Q50. The -5V regulator is supplied from the diode bridge D13-D16. Smoothing and reservoir capacitors are C57, C58, C61 and C62. Capacitor C56 ensures that any ripple in the +5V line will not affect the -5V stabilizing comparator IC10b. The circuit is stabilized by C59 and C60. For certain purposes a +5V rail with additional filtering by capacitors C43/C44, C46/C47 and C54/C55 is provided, and identified on the circuit as +5V 'A'.

+5V Stabilization

4.49 The reference voltage is provided from the +5V rail by zener diode D8 which is connected to the comparator IC10a/2. The other input to the comparator (IC10a/1) is from the 0V rail. The comparator function is to ensure that the 0V rail is maintained 5.1V below the voltage of the +5V rail. Any change from this state will cause IC10a to apply a signal to Q30 which will regulate the current in Q50 to restore the correct condition.

-5V Stabilization

4.50 The -5V stabilizing comparator is IC10b, in which both inputs should be at 0V when conditions are correct. IC10b/7 is connected to the 0V rail and IC10b/6 to the mid-point of a potential divider (R99, R97 and R98) which is connected between the stabilized +5V rail and the -5V rail. If the level at IC10b departs from 0V then a signal from IC10b/6 will regulate the current in Q29 to correct the error.

On/Off Switching

4.51 The single pole on/off switch S50 operates in the negative supply line from the rectifiers D13-D16. It also switches off the +5V supply by disconnecting the reference zener diode D8 in the 'off' position.

CDI Chip 2V Supply

4.52 A stabilized +2V supply is derived from the +5V rail via the regulator Q15 which is controlled by Q16 from a reference voltage provided by the CDI Chip at IC6/11.

LF MULTIPLIER ASSEMBLY (OPTION)

Summary

4.53 Frequency multiplication is achieved by a voltage controlled oscillator which runs at a multiple of the input frequency. The divided oscillator frequency is phase-compared with the input frequency to provide fine control of the oscillator signal. The circuit is shown in Fig. 7 at the back of the book.

Circuit Description

- 4.54 The LF signal is fed from the input amplifier (para. 4.7) into the LF Multiplier p.c.b. Referring to Fig. 7, the signal is fed via C1 into the Operational Amplifier IC1, which functions as a Schmitt Trigger. With an input of approximately 400 mV peak-to-peak applied to IC1 an output of approximately 6V peak-to-peak will be fed into IC2/14.
- 4.55 IC2 contains a voltage-controlled oscillator (VCO) in a phase-locked loop (PLL). The factors controlling the oscillator frequency are:-
- (1) The voltage on pin 9 of IC2.
 - (2) The resistance between pin 11 and the negative rail.
 - (3) The capacitance between pins 6 and 7.
 - (4) The output of the phase comparator at pin 13.
- 4.56 The oscillator output at IC2/4 is fed via Q3 to a divider chain (IC3 and IC4). The divided signal is fed back via Q2 to pin 3 of IC2, where it is compared in phase with the original signal on pin 14. This phase comparison voltage is fed out via pin 13 and R4 to pin 9, to pull the oscillator to a frequency which is a precise multiple of the original input.
- 4.57 The overall division ratio of IC3 and IC4 is $\div 100$ in the 9913 and $\div 50$ in the 9911. This is determined by the fitting of link LK1 or LK2 on IC3. The division ratios are different because the input signal is prescaled by 2 in the 9911 CDI Chip.

NOTE 1: When fitting a new LF Multiplier p.c.b. the link fitting on IC3 must be checked, as instructed on the circuit diagram Fig. 7.

DISPLAY ASSEMBLY: LINKS LK1 AND LK2

NOTE 2: Referring to para. 4.40 the links LK1 and LK2 in the collector circuit of Q27 are provided in later versions of the Display Assembly to permit the use of different types of LED seven segment indicators. Refer to Parts List 1 for details.

CHAPTER 5
MAINTENANCE

TABLE 5: TEST EQUIPMENT REQUIRED

Item No.	Preferred Item	Remarks
1	Digital Multimeter Racal 9077	Provides 10 mV resolution on 50V range, DC input resistance 10 MΩ
2	Oscilloscope BWD 525	Bandwidth d.c. to 50 MHz Sensitivity 50 mV/cm
3	Frequency Standard	1 MHz; accuracy ± 1 part in 10^8 Output 1V r.m.s. nominal
4	Signal Generator Racal 9061) 9062) combination 9063) *9064)	Required range 10 Hz to 200 MHz* Output from 5 mV r.m.s. to 1V r.m.s., into 50Ω NOTE: LF Signal Generator must have signal-to-noise ratio better than 40 dB.
5	Millivoltmeter Racal 9301	Required frequency range: 10 kHz to 200 MHz (120 MHz for 9911) Measurement: 1 mV to 3V
6	Coaxial leads, 50Ω (quantity 2)	BNC to BNC. Length 3 ft. (1 metre) approximately.
7	Terminating Pad, BNC, 50Ω (quantity 1)	
8	Terminating connector, BNC. 50Ω (T Piece, quantity 1)	
9	Power Supply 240V \pm 2%, 50 Hz Single phase, line neutral and earth.	

*NOTE: For the 9911 the required signal generator range is 10 Hz to 120 MHz. The 9064 unit is therefore not required.

REMOVAL OF COVERS

WARNING: DANGEROUS AC VOLTAGES ARE EXPOSED WHEN COVERS ARE REMOVED WITH AC SUPPLY CONNECTED.

- 5.1
- (1) Set the POWER switch to 'off', switch off and unplug the a.c. supply at the supply point.
 - (2) Remove 4 screws from the bottom cover.
 - (3) Remove the rubber plugs (located near to the rear end) from both side panels of the instrument and slacken, by about two turns, the screws revealed.
 - (4) Grip the rear panel assembly and ease it back from the main case to the maximum extent available (about 5 mm).
 - (5) The rear edge of either cover can now be lifted and the cover withdrawn outwards and rearwards.
 - (6) To replace the covers reverse the above procedure.

TRANSFORMER VOLTAGE SELECTION

5.2 The instrument will normally be dispatched with the transformer primary tapping set to the 223V to 251V supply range. To check the selection proceed as follows.

- (1) Unplug the power cable from the supply and remove the top cover (see previous paragraph).
- (2) Refer to the diagrams on the next page and:-
 - (a) Note the diagram which corresponds to the local a.c. supply voltage.
 - (b) Connect the correct link(s) and make the required line lead connection (L) as indicated in the appropriate diagram.
- (3) Verify that the label on the rear panel indicates correctly the selected voltage range. Alternative labels are provided with the instrument for ranges other than 223V to 251V.
- (4) Replace the top cover.

188-212V

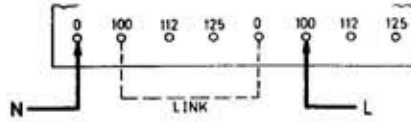

200-225V

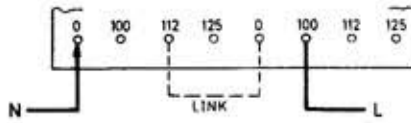

212-239V

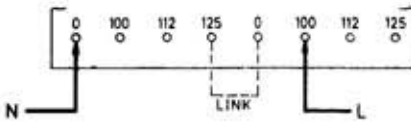

223-251V

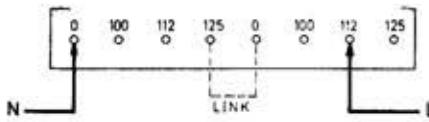

235-265V

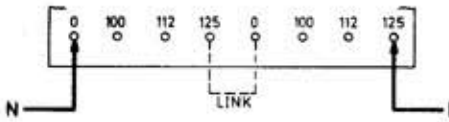

188V TO 265V

94-106V

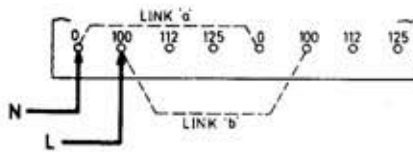

106-119V

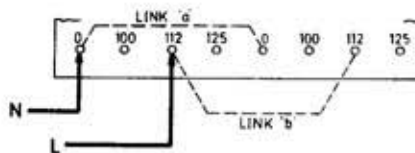

94V TO 132V

118-132V

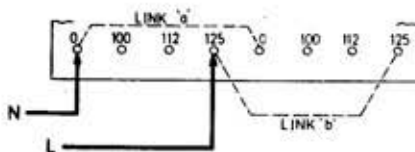

Mains Transformer
Voltage Selection Diagrams

WOH 6230

Fig. 5.1

FUSES

- 5.3 (1) Check that the power fuse on the rear panel is correctly rated for the supply voltage, as follows. The fuse is a glass cartridge type, 5 x 20 mm.

<u>Supply Range</u>	<u>Fuse Rating</u>	<u>Racal Part No.</u>
188V to 265V	100 mA anti-surge	23-0033
94V to 132V	200 mA anti-surge	23-0027

POWER LEAD

- 5.4 Fit a suitable plug to the power lead in accordance with the standard colour code:-

Brown Line
Blue Neutral
Green/Yellow Earth (Ground)

POWER SUPPLY CHECK

- 5.5 (1) Remove the covers and prepare the power supply as described in the preceding paragraphs.
- (2) With power supply connected, switch POWER to ON.
- (3) Using the multimeter (Page 5.1, Table 1, item 1) check the d.c. voltages at the following points on the main p.c.b. (relative to chassis).
Fig. 3 or Fig. 5 at the back of the book show the component layouts.

<u>Test Point</u>	<u>Measurement</u>	<u>Remarks</u>
TP10	+5.0V \pm 0.1V	See NOTE
TP9	-5.2V \pm 0.2V	below

NOTE: There are no adjustments in the power supply circuit.
If the 5V supplies are outside the limits given above, the mains supply voltage and the transformer line lead connection and links (see page 5-3) should be carefully checked. If these are correct the zener reference diode D8 should be checked.

PERFORMANCE TESTS AND CALIBRATION

NOTE: If the Racal Synthesized Signal Generator is used, with its frequency standard synchronised to that of the frequency meter under test, a readout accuracy of ± 1 count will be obtained.

Segment, Decimal Point and Self Check

- 5.6 (1) Switch on and set the CHECK/NORMAL/LF switch to CHECK.

- (2) Refer to Table 6 and verify correct readout and decimal point position in each position of the RESOLUTION switch.
- (3) For the segment check apply an earth to IC19 pin 3 and check that all display indicators read '8'.

TABLE 6

Decimal Point and Self Check

Resolution Switch Setting	Display	
	9911	9913
1 Hz	1.000000	01.000000
10 Hz	01.00000	001.00000
100 Hz	001.0000	0001.0000

Sensitivity Check

5.7 Test Equipment

HF Signal Generator (Page 5-1, Table 5, item 4).
BNC Terminating Connector and 50Ω load.

5.8 Procedure

- (1) Set the controls as follows:-
 - (a) CHECK/NORMAL/LF switch to NORMAL.
 - (b) SENSITIVITY control fully anticlockwise to 10 mV position (but not in the VHF 'click' position in 9913).
- (2) Connect the signal generator, with 50Ω termination, to the Input socket.
- (3) Set the signal generator output level to 10 mV r.m.s. Apply the frequencies in Table 7 and check for stable and accurate counting.

TABLE 7

Sensitivity Check: Normal Range

Resolution Switch	Input Frequency	Input Level (r.m.s.)
1 Hz	10 Hz)
10 Hz	10 kHz)
100 Hz	30 MHz)
) 10 mV r.m.s.

- (4) With a 10 MHz input increase the signal level to greater than 500 mV. Turn the SENSITIVITY control clockwise and verify that counting ceases.
- (5) Turn the SENSITIVITY control back to the 10 mV position and reset the signal generator output level to 10 mV.
- (6) With the 9911 only, increase the signal generator frequency to 125 MHz and adjust potentiometer R58* (on the main p.c.b.) to the centre of the travel over which satisfactory counting is obtained

VHF Sensitivity Check (9913 Only)

- 5.9
- (1) Select NORMAL and set the SENSITIVITY fully anticlockwise to the 'click' VHF position.
 - (2) Refer to Table 8 and apply the signals from the terminated signal generator. Verify stable and accurate counting.

*NOTE: Potentiometer R58 is not fitted to some early models in which R58 is a fixed resistor with value selected on test during assembly.

TABLE 8

Sensitivity Check: 9913 VHF Range

Resolution Switch	Input Frequency	Input Level (r.m.s.)
100 Hz (((((100 MHz	10 mV
	150 MHz	10 mV
	200 MHz	50 mV

LF Multiplier Check (Option)

- 5.10 (1) Set the controls as follows:-
- (a) CHECK/NORMAL/LF switch to LF.
 - (b) SENSITIVITY control anticlockwise to the 10 mV position.
 - (c) RESOLUTION switch to 1Hz position.
- (2) Set the signal generator level to 10 mV r.m.s. and apply frequencies of:-
- (a) 10 Hz
 - (b) 5 kHz
- to the terminated input socket.
- (3) Verify correct counting.

FREQUENCY STANDARD CALIBRATION

5.11 The 'cycle drift' method of frequency calibration, described below, is suitable for oscillators which have temperature stability characteristics of up to 1 part in 10^7 . The higher stability oscillators, such as the Racal 9421 and 9442, require specialised equipment such as the Tracor Frequency Difference Meter Type 527A, if the optimum calibration is to be achieved.

5.12 Test Equipment

Oscilloscope

1 MHz external frequency standard, with accuracy better than one part in 10^7 .

Internal Standard Amplitude and Calibration Check

- 5.13 (1) Remove the top cover.
- (2) Set the CHECK/NORMAL/LF switch to NORMAL.

9911 Only

- (3) Set the oscilloscope to the $2 \mu\text{s}/\text{cm}$ range. Connect the probe to pin 6 of the CDI Chip IC6. Verify an amplitude of not less than 3V peak-to-peak.
- (4) Connect the 1 MHz external standard to the External Trigger input of the oscilloscope.
- (5) Re-connect the oscilloscope to IC6 pin 6 and observe the oscilloscope trace.
- (6) Adjust the trimming capacitor of the internal oscillator for a stationary trace. Trimming capacitor references are:-
- (a) If on main p.c.b., (early models) C33.
 - (b) If on separate p.c.b. 19-0834, C4, accessible via rear panel aperture.
 - (c) The trimmer for the optional oscillators is accessible via rear panel aperture. The 9421 has two trimmers Coarse and Fine.
- (7) If, in a period of 10 seconds not more than one cycle of displayed waveform moves past a fixed reference point on the oscilloscope face, the accuracy is 1 part in 10^7 .

9913 Only

- (8) Proceed as in operations (3) to (7) except that:-
 - (a) The oscilloscope range must be set to 1 μ s/cm.
 - (b) The internal standard monitoring point is the 1 MHz BNC output socket on the rear panel.

FITTING OPTIONAL FREQUENCY STANDARD UNIT

- NOTES:
1. Operation (1) applies only to early models. In later models the oscillator is on a separate p.c.b. attached to the inner face of the rear panel.
 2. The black plate referred to below is not fitted on early models.

Procedure

- 5.14
- (1) If the discrete component oscillator is mounted on the main p.c.b. (early models) remove link LK14 and crystal XL1 from the p.c.b.
 - (2) Unsolder the leads from pins 1, 2 and 3 of the discrete component oscillator p.c.b. (later models). Extract the two retaining screws (and spacers) from the rear panel and remove the p.c.b.
 - (3) Remove the black plate (if fitted) from the rear panel trimming aperture, and retain the screws.
 - (4) Attach the optional frequency standard unit to the inner face of the rear panel, align the fixing holes in the top of the unit with the rear panel holes and make secure with two M3, 6 mm, screws. (The screws removed with the black plate can be used).
 - (5) Solder the connecting leads to pins 1, 4 and 7 of the frequency standard base, as shown in the circuit diagram.
 - (6) If frequency standard Type 9421 is being fitted check that pins 5 and 6 on the base are linked.
 - (7) Replace the instrument cover.
 - (8) Carry out the instrument CHECK procedure to verify satisfactory functioning.
 - (9) Calibration of the frequency standard must be carried out before operational use. Refer to para. 5.13.

FITTING LF FREQUENCY MULTIPLIER ASSEMBLY (OPTION 09)

- 5.15 The LF Multiplier p.c.b. is attached by two screws to the right hand side panel of the instrument, towards the rear.
- (1) Remove the top cover (para. 5.1).
 - (2) If the optional frequency standard unit is fitted, it must be detached by removing the two retaining screws from the rear panel and moving the unit to one side. Do not unsolder the connections.
 - (3) Connect pins 1 to 5 of the LF Multiplier p.c.b. to the main p.c.b. in accordance with the circuit diagram. (Fig. 4 or Fig. 6).
 - (4) Attach the LF Multiplier p.c.b. to the side panel using two M3 screws, and spacers, to the threaded holes provided. Dress the wiring neatly.
 - (5) Refit the frequency standard unit.
 - (6) Replace the top cover. Connect power and carry out an operational check.

DISMANTLING

Removal of Front Panel and Display PCB

- 5.16 To change a component such as an LED indicator it is necessary to detach the front panel from the Display Assembly.
- (1) Disconnect the power supply and remove the knob of the SENSITIVITY control.
 - (2) Remove the covers (para.5.1) but when doing so, completely remove the two side panel screws which were slackened when removing the covers.
 - (3) Carefully ease back the rear panel so as to allow the two lengths of coloured trim to be drawn out of the side panel slots. Temporarily refit the rear panel.
 - (4) Inside the instrument unsolder the connections from the Input socket, and the resistor and capacitor from the centre contact of the Sensitivity potentiometer. In the 9913 unsolder the connections from the switch section of the Sensitivity control.
 - (5) On the underside, remove the two Pozidriv screws which secure the earthing bracket of the BNC input socket.
 - (6) Remove the four Pozidriv screws which secure the Display PCB to the front panel. Remove the caps from RESOLUTION and CHECK/NORMAL switches.
 - (7) Remove the two screws which secure the front panel brackets to the side panel trim slots.
 - (8) Hold the Display PCB in position and ease the front panel away.
 - (9) The Display PCB can now be serviced in position, or unplugged from its socket, as required.

Removal of Main PCB

5.17 Due to excellent accessibility for servicing, removal of the main p.c.b. will rarely be necessary. It can be withdrawn either from the front or the rear. The rear panel method is described below.

- (1) Remove the Display Assembly as described in para.5.16.
- (2) Unsolder the wiring between rear panel items and main p.c.b.
- (3) Unsolder the connections between the regulator transistor Q50 on the side frame and the main p.c.b.

NOTE: If preferred transistor Q50 can remain connected to the p.c.b. and be unscrewed from the side frame, but this transistor is not supplied with a replacement p.c.b.

- (4) Remove the three Pozidriv screws which secure the p.c.b. to the main frame and slide out the p.c.b. towards the rear.

Replacement of Main PCB

- 5.18
- (1) Fit and secure the main p.c.b.
 - (2) Fit and secure the Display Assembly and the front panel, reversing the procedure of para.5.16.
 - (3) Fit the trim strips into the side panel slots.
 - (4) Fit the rear panel on to the main frame and solder the connections.
 - (5) Fit transistor Q50 to the side frame and solder the connections to the main p.c.b.
 - (6) Fit the two screws into the side panel apertures do not tighten until covers are fitted.
 - (7) Refit the covers when tests are completed. Replace the rubber plugs over the side panel screws.

SECTION 3
PARTS LISTS
CIRCUIT DIAGRAMS
AND
COMPONENT LAYOUTS

ORDERING OF SPARE PARTS

1. To be assured of satisfactory service when ordering replacement parts, the customer is requested to include the following information.
 - (a) Instrument type and serial number.
 - (b) The type reference of the Assembly in which the particular items is located (for example, '19-0834').
 - (c) The Racal Part number and circuit reference of each item being ordered.

It should be noted that a minimum charge of £5 sterling is applicable to all U.K. orders.

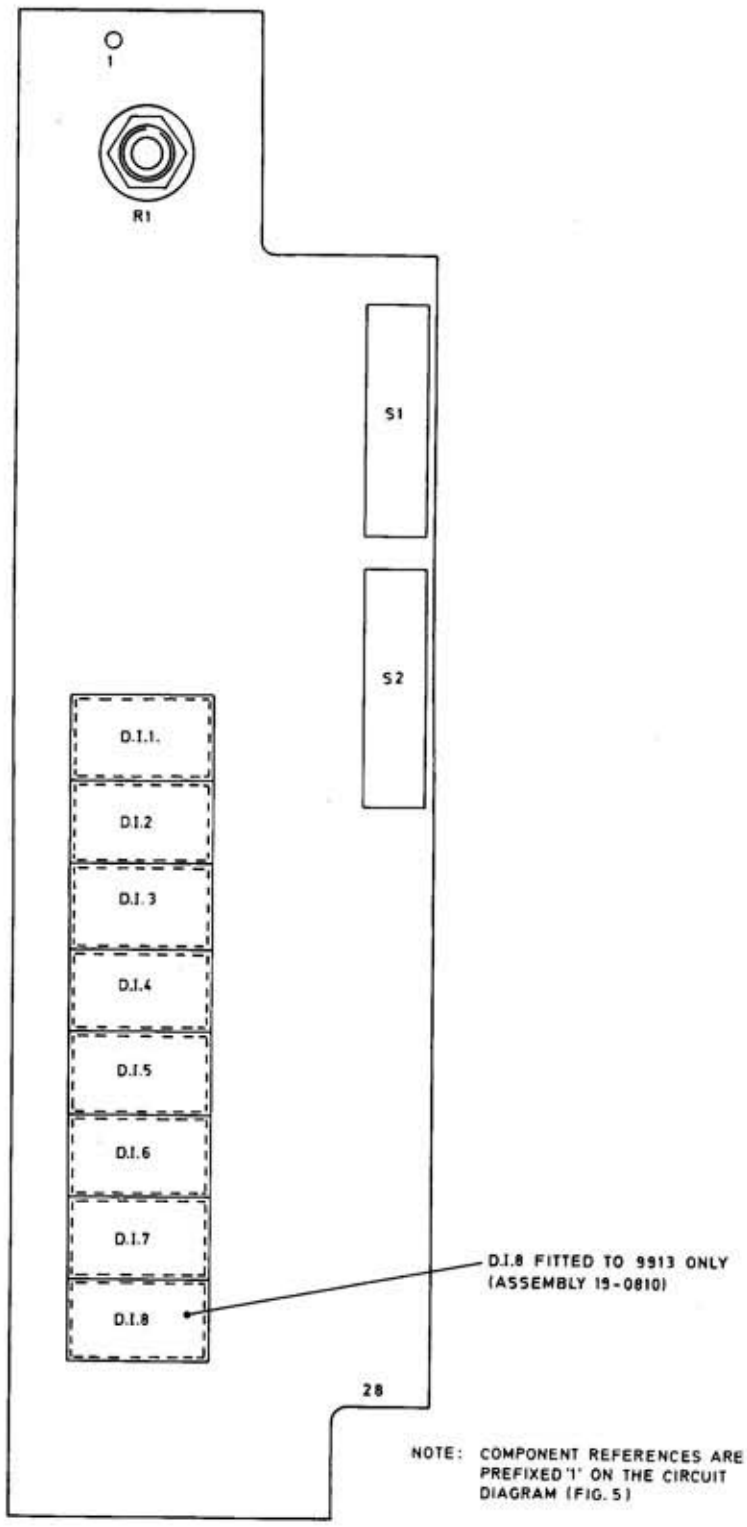

19-0810	9913
1	
19-0829	9911
1	
WOH 6230	

Component Layout : Display Assemblies 19-0810 (9913) And 19-0829 (9911)

Fig. 1

PARTS LISTS FOR DISPLAY ASSEMBLIES

9911 and 9913

NOTE: Component references are prefixed '1' on the circuit diagrams (Fig.4 and Fig.6).

Part No.	Description	Rat.	Tol. %	Value	Component Reference
----------	-------------	------	--------	-------	---------------------

DISPLAY ASSEMBLY 19-0829 (9911 Only)

Resistors

20-6627	Variable, log, panel mounting			1M	R1
---------	-------------------------------	--	--	----	----

Switches

23-4080	Slide, 2-pole, 3-position				S1, S2
---------	---------------------------	--	--	--	--------

Indicators

*	Indicators, seven segment (See NOTE below)				DI.1 to DI.7
---	--------------------------------------------	--	--	--	--------------

DISPLAY ASSEMBLY 19-0810 (9913 Only)

Resistors

20-6626	Variable, log, panel mounting with switch			1M	R1
---------	-------------------------------------------	--	--	----	----

Switches

23-4080	Slide, 2-pole, 3-position				S1, S2
---------	---------------------------	--	--	--	--------

Indicators

*	Indicators, seven segment (see NOTE below)				DI.1 to DI.8
---	--------------------------------------------	--	--	--	--------------

* NOTE: In earlier versions of the Display Assembly (not fitted with links LK1 and LK2) the 7-Segment Indicator Part No. 26-1504 must be used. In later versions fit link LK1 or LK2, as follows:-

<u>Indicator Type</u>	<u>Link Fitted</u>
26-1505	LK1
26-1504	LK2

Do not mix two types of indicator on one assembly.

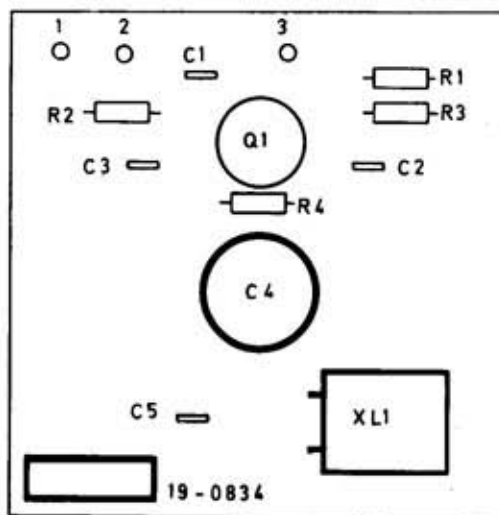
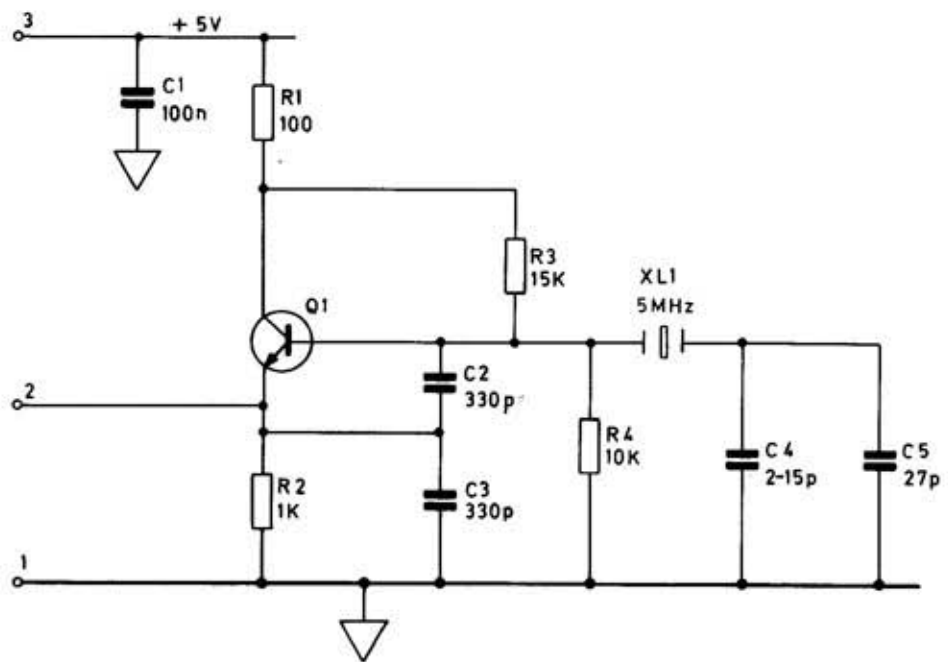

6230

WOH 6230	19-0834
1	

Circuit And Layout
5MHz Oscillator PCB 19-0834

Fig. 2

PARTS LIST

5 MHz CRYSTAL OSCILLATOR ASSEMBLY (19-0834)

Part No.	Description	Rat	Tol %	Value	Component Reference
<u>Resistors</u>					
		<u>W</u>		<u>Ω</u>	
20-2101	Carbon Film	$\frac{1}{4}$	5	100	R1
20-2101	Carbon Film	$\frac{1}{4}$	5	1k	R2
20-2103	Carbon Film	$\frac{1}{4}$	5	10k	R4
20-2153	Carbon Film	$\frac{1}{4}$	5	15k	R3
<u>Capacitors</u>					
		<u>V</u>		<u>F</u>	
21-1616	Ceramic	12	20	100n	C1
21-2621	Silver Mica	125	5	27p	C5
21-2631	Silver Mica	125	5	330p	C2,3
21-6030	Trimmer			2-15p	C4
<u>Transistors</u>					
22-6017	Silicon NPN (2N2369)				Q1
<u>Crystal</u>					
17-2087	Crystal Assembly, 5 MHz				XL1

NOTE: In early models the 5 MHz oscillator is mounted on the main p.c.b. Component details are the same as in Assembly 19-0834, but the circuit references differ. Both circuits are shown in Fig. 4 at the back of the book.

PARTS LIST FOR CHASSIS, FRONT AND REAR PANELS (Fig. 4 and Fig. 6)

9911 and 9913

Part No.	Description	Rat.	Tol %	Value	Component Reference
<u>CHASSIS ASSEMBLY COMPONENTS (11-1063 and 11-1064)</u>					
	<u>Resistors</u>	<u>W</u>		<u>Ω</u>	
20-4658	Metal Oxide	1	5	100k	R150
	<u>Capacitors</u>				
21-4528	Polyester	400	10	47n	C150
21-1525	Ceramic	500	10	270p	C151
	<u>Transistors</u>				
22-6081	(MJE520)				Q50
<u>FRONT PANEL ASSEMBLY COMPONENTS (11-1084 and 11-1085)</u>					
23-4065	Switch, toggle, POWER				S50
23-3030	Socket, coaxial, BNC, INPUT				
23-3019	Plug, free, for BNC sockets				
<u>REAR PANEL ASSEMBLY COMPONENTS (11-1091)</u>					
17-4057	Transformer, mains				T50
19-0834	5 MHz Oscillator p.c.b. (refer to Parts List 19-0834)				
23-0033	Fuselink (188V to 265V) 100 mA ant surgen)				FS50
23-0027	Fuselink (94V to 132V) 200 mA ant surgen)				
23-3005	Socket, coaxial, BNC)				
23-3019	Plug, free, for BNC socket)				9913 only

PARTS LIST

MAIN PCB ASSEMBLY 19-0828 (Fig. 4)

(9911 Only)

Part No.	Description	Rat	Tol %	Value	Component Reference	Part No.	Description	Rat	Tol %	Value	Component Reference
<u>Resistors</u>						<u>Capacitors</u>					
		<u>W</u>		<u>Ω</u>				<u>V</u>		<u>F</u>	
20-1515	Carbon Film	0.1	5	180	R13,20	21-0566	Alum. Elec.	25		1000 μ	C62
20-1520	Carbon Film	0.1	5	10	R9	21-0575	Alum. Elec.	16		4700 μ	C61
20-1540	Carbon Film	0.1	5	27	R12, 14, 19, 22	21-1038	Tantalum	6.3		47 μ	C3, 4, 6, 12, 16, 18, 20, 21, 43, 46, 54, 56, 58, 59, 60
20-2100	Carbon Film	$\frac{1}{4}$	5	10	R18, 23						
20-2101	Carbon Film	$\frac{1}{4}$	5	100	R85						
20-2102	Carbon Film	$\frac{1}{2}$	5	1k	R57, 60, 68, 71, 80, 104, 110	21-1039	Tantalum	16		22 μ	C57
20-2103	Carbon Film	$\frac{1}{4}$	5	10k	R48, 52, 53, 54, 55, 61, 63, 69, 75, 77, 79, 83, 87, 96	21-1046	Tantalum	3		220 μ	C1, 17
20-2106	Carbon Film	$\frac{1}{4}$	5	10M	R2	21-1503	Ceramic	500	$\pm 1p$	3.9p	C2
20-2121	Carbon Film	$\frac{1}{4}$	5	120	R47	21-1514	Ceramic	500	10	33p	C13
20-2122	Carbon Film	$\frac{1}{4}$	5	1.2k	R97	21-1515	Ceramic	500	10	39p	C7
20-2150	Carbon Film	$\frac{1}{4}$	5	15	R73, 74	21-1523	Ceramic	500	10	180p	C30
20-2152	Carbon Film	$\frac{1}{4}$	5	1.5k	R89, 105	21-1524	Ceramic	500	10	220p	C64
20-2182	Carbon Film	$\frac{1}{4}$	5	1.8k	R102	21-1532	Ceramic	500	20	1n	C31, 37, 40
20-2220	Carbon Film	$\frac{1}{4}$	5	22	R100	21-1589	Ceramic	10	+50	220n	C41
20-2221	Carbon Film	$\frac{1}{4}$	5	220	R4, 11, 15, 27, 31	21-1616	Ceramic	12	+80	100n	C5, 8, 9, 10, 11, 14, 15, 19, 22, 27, 28, 29, 38, 42, 44, 47, 49, 50, 53, 55
20-2222	Carbon Film	$\frac{1}{4}$	5	2.2k	R3, 6, 17, 24, 25, 29, 76, 108						
20-2223	Carbon Film	$\frac{1}{4}$	5	22k	R86						
20-2271	Carbon Film	$\frac{1}{4}$	5	270	R8, 21, 30, 46						
20-2272	Carbon Film	$\frac{1}{4}$	5	2.7k	R70						
20-2330	Carbon Film	$\frac{1}{4}$	5	33	R1						
20-2332	Carbon Film	$\frac{1}{4}$	5	3.3k	R59, 109						
20-2471	Carbon Film	$\frac{1}{4}$	5	470	R5, 26, 28, 32						
20-2472	Carbon Film	$\frac{1}{4}$	5	4.7k	R101						
20-2561	Carbon Film	$\frac{1}{4}$	5	560	R50, 51	22-1029	Silicon, general purpose (1N 4149)				D1, 3
20-2562	Carbon Film	$\frac{1}{4}$	5	5.6k	R62	22-1602	Rectifiers	100		5A	D9, 10, 11, 12, 13, 14, 15, 16
20-2680	Carbon Film	$\frac{1}{4}$	5	68	R40	22-1805	Voltage regulator 3.9V	5%			D7
20-2681	Carbon Film	$\frac{1}{4}$	5	680	R7, 45, 49	22-1808	Voltage regulator 5.1V	5%			D8
20-2820	Carbon Film	$\frac{1}{4}$	5	82	R90						
20-2821	Carbon Film	$\frac{1}{4}$	5	820	R10, 16						
20-3470	Metal Oxide	$\frac{1}{2}$	5	47	R103						
20-4013	Metal Oxide	$\frac{1}{4}$	1	8.2k	R98						
20-4094	Metal Oxide	$\frac{1}{4}$	1	6.8k	R99						
20-5055	Wirewound	2 $\frac{1}{2}$	5	3.9	R107						
20-7025	Variable			200	R58*						
<u>Resistor Arrays</u>											
20-5500	DIL Array	7 x 56			R91						
20-5501	DIL Array	8 x 220			R81						
20-5502	DIL Array	13 x 1k			R82						
20-5503	DIL Array	13 x 10k			R78						

* NOTE: Potentiometer R58 is not fitted in some early models.

MAIN PCB ASSEMBLY 19-0828 (Continued)

(9911)

Part No.	Description	Rat	Tol %	Value	Component Reference	Part No.	Description	Rat	Tol %	Value	Component Reference
<u>Integrated Circuits</u>						<u>Transistors</u>					
22-4048	Dual-D Bistable (7474)				IC3	22-6009	Silicon, npn		(2N4124)		Q26
22-4049	Decade Counter (7490)				IC14	22-6017	Silicon, npn		(2N2369)		Q9, 10, 11, 12, 14, 16, 27
22-4058	4 to 10 Line Decoder (7442)				IC17	22-6059	Silicon, npn		(BFX89)		Q2, 7
22-4059	Hex Inverter (7404)				IC2,7	22-6079	Silicon, npn		(ZTX313L)		Q3, 4, 5, 6
22-4060	Quad 2-Input NAND Gate (open collector) (7403)				IC5, 15	22-6081	Silicon, npn		(MJE520)		Q29
22-4061	Hex Inverter (open collector) (7405)				IC11	22-6101	Silicon, FET		(W300A)		Q1
22-4087	Quad 2 to 1 Multiplexer (74157N)				IC18	22-6113	Silicon, pnp		(ZTX550)		Q15, 17, 18, 19, 20, 21, 22, 23, 30
22-4128	BCD to 7 Segment Decoder (74247)				IC19	<u>Inductors</u>					
22-4202	Dual Freq. Comparator Op. Amp. (747)				IC10	23-7016	Inductor			22 μ H	L1, L2
22-4505	Schottky Quad 2-Input NAND Gate (74500)				IC8	23-7014	Inductor			10 μ H	L3
22-4507	Dual Master Slave-Type Bistable (MC10131L)				IC9	<u>Miscellaneous</u>					
22-4528	Triple 3-Input Line Receiver (MC10116P)				IC12	23-3213	IC Holder 24 pin for IC6				
22-4601	60 MHz CDI LSI (Racal)				IC6	23-8000	Ferrite Bead			FX1, FX2, FX3	

AMENDMENT INFORMATION

Check with Section 4 at the back of the book for latest information.

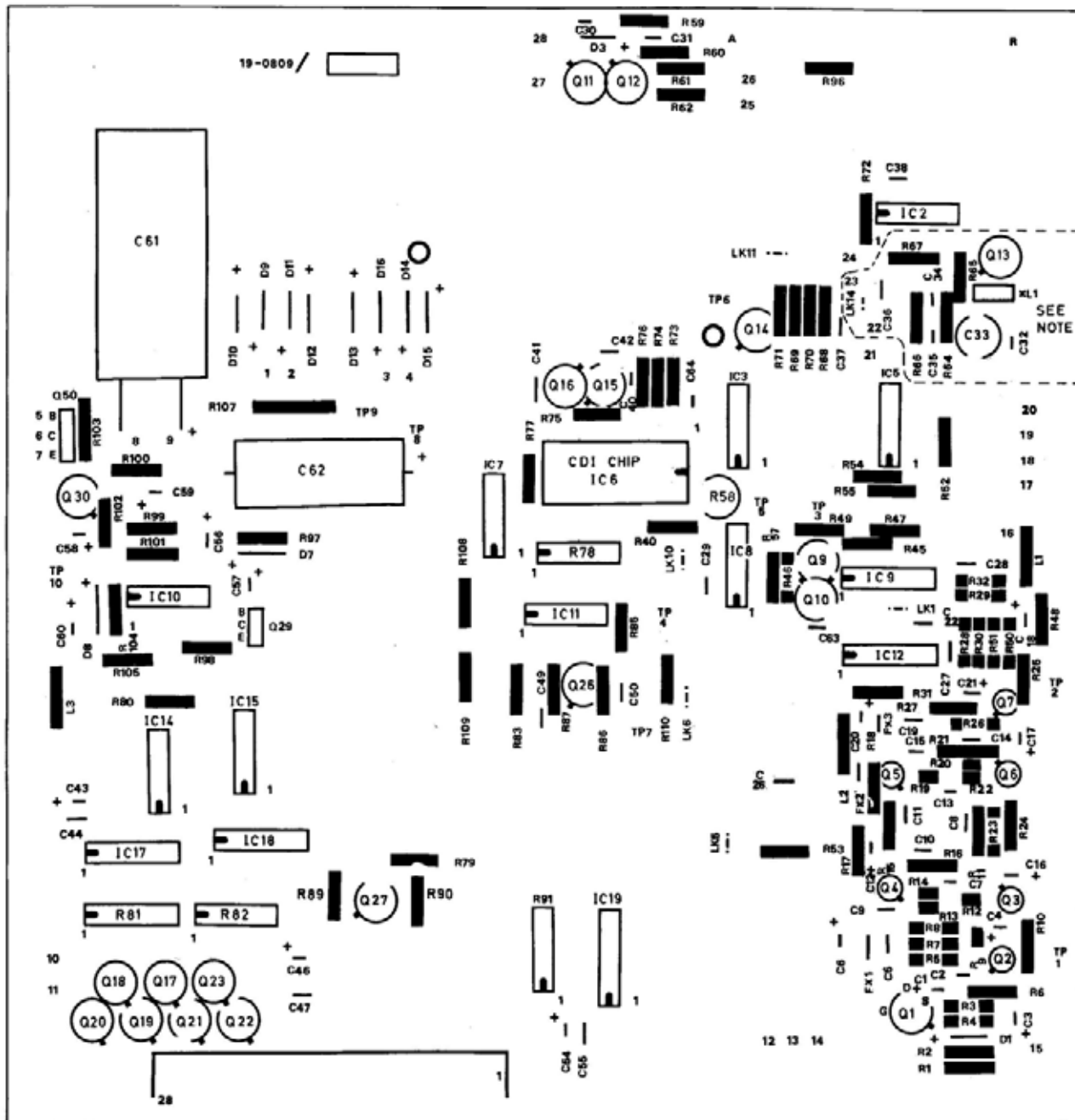

NOTE: COMPONENTS ENCLOSED BY DASHED LINE ARE FITTED
IN EARLY MODELS ONLY (5MHZ OSCILLATOR)

2N3819



Component Layout
Main P.C.B. Assembly 19-0828
(9911)

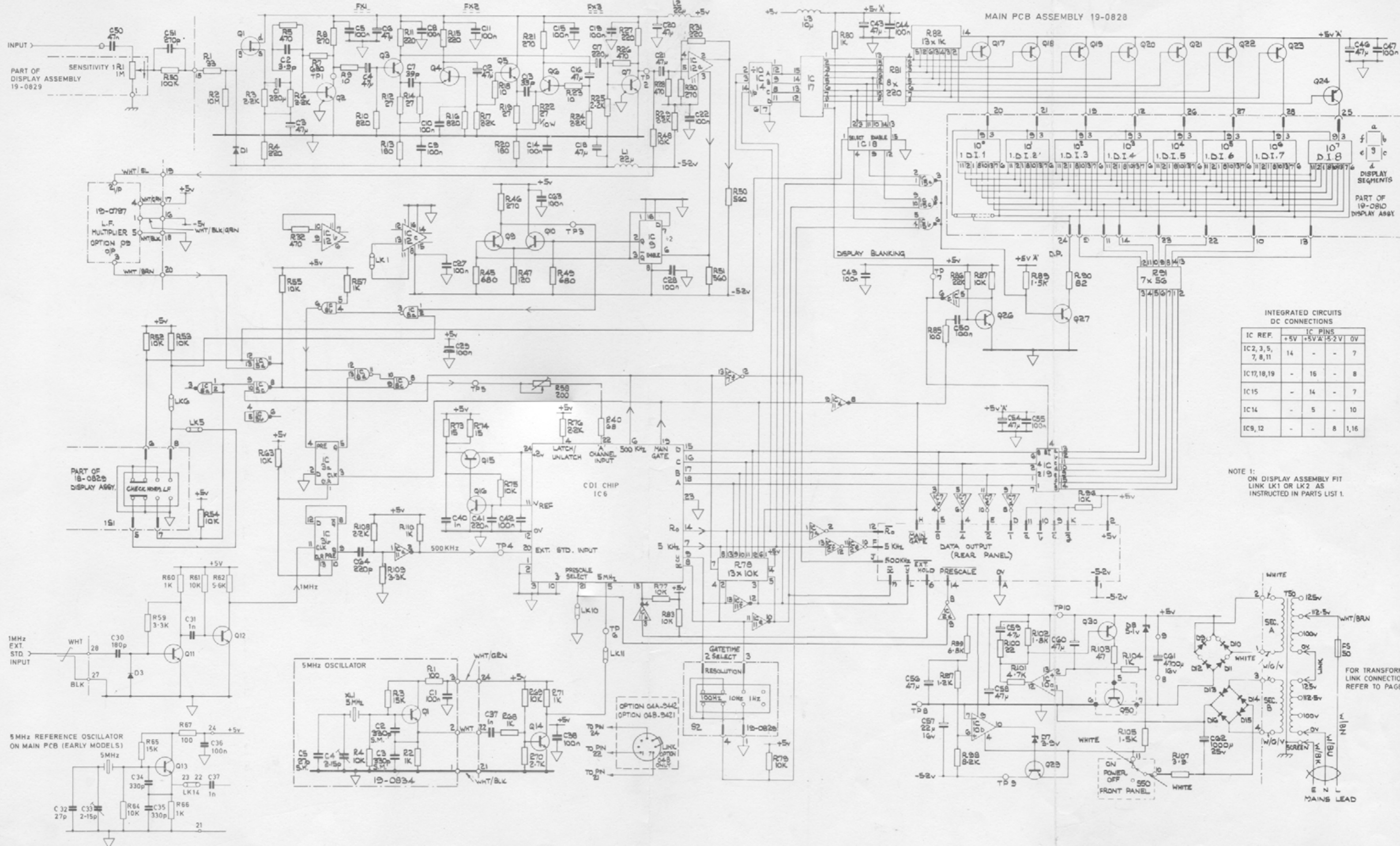

MAIN PCB ASSEMBLY 19-0828

INTEGRATED CIRCUITS DC CONNECTIONS

IC REF.	+5V	+5V _A	+5.2V	0V
IC2, 3, 5, 7, 8, 11	14	-	-	7
IC17, 18, 19	-	16	-	8
IC15	-	14	-	7
IC14	-	5	-	10
IC9, 12	-	-	8	1, 16

NOTE 1:
ON DISPLAY ASSEMBLY FIT LINK LK1 OR LK2 AS INSTRUCTED IN PARTS LIST 1.

FOR TRANSFORMER LINK CONNECTIONS REFER TO PAGE 5-3.

THIS PAGE INTENTIONALLY
LEFT BLANK

PARTS LIST

MAIN PCB ASSEMBLY 19-0809 (Fig. 6)

(9913 Only)

Part No.	Description	Rat	Tol %	Value	Component Reference	Part No.	Description	Rat	Tol %	Value	Component Reference
Resistors						Capacitors					
		<u>W</u>		<u>Ω</u>				<u>V</u>		<u>F</u>	
20-1513	Carbon Film	0.1	5	39	R9	21-0566	Electrolytic	25		1000μ	C62
20-1515	Carbon Film	0.1	5	180	R13, 20	21-0575	Electrolytic	16		4700μ	C61
20-1531	Carbon Film	0.1	5	47	R44	21-1038	Tantalum	6.3	20	47μ	C3, 4, 6, 12, 16, 18, 20, 21, 43, 46, 54, 56, 58, 59, 60,
20-1540	Carbon Film	0.1	5	27	R12, 14, 19, 22						
20-2101	Carbon Film	1/4	5	100	R85	21-1039	Tantalum	16	20	22μ	C57
20-2102	Carbon Film	1/4	5	1k	R33, 35, 45, 49, 57, 60, 68, 71, 80, 104	21-1046	Tantalum	3	20	220μ	C1, 17
20-2103	Carbon Film	1/4	5	10k	R39, 48, 52, 53, 54, 55, 56, 61, 63, 69, 75, 77, 79, 83, 87, 96	21-1509	Ceramic	500	10	12p	C2, 7
20-2106	Carbon Film	1/4	5	10M	R2	21-1510	Ceramic	500	10	15p	C13
20-2121	Carbon Film	1/4	5	120	R47	21-1522	Ceramic	500	10	150p	C39
20-2122	Carbon Film	1/2	5	1.2k	R97	21-1523	Ceramic	500	10	180p	C30
20-2150	Carbon Film	1/4	5	15	R73, 74	21-1532	Ceramic	500	20	1n	C31, 37, 40
20-2152	Carbon Film	1/4	5	1.5k	R89, 105	21-1589	Ceramic	10	+50 -20	220n	C41
20-2182	Carbon Film	1/4	5	1.8k	R102	21-1616	Ceramic	12	+80 -20	100n	C5, 8, 9, 10, 11, 14, 15, 19, 22, 24, 25, 26, 27, 29, 38, 42, 44, 47, 49, 50, 55, 63
20-2220	Carbon Film	1/4	5	22	R100						
20-2221	Carbon Film	1/4	5	220	R4, 11, 15, 27, 30, 31, 72						
20-2222	Carbon Film	1/4	5	2.2k	R3, 6, 17, 24, 25, 29, 38, 76						
20-2223	Carbon Film	1/4	5	22k	R86						
20-2271	Carbon Film	1/4	5	270	R8, 21, 37, 41, 42, 43, 46	22-1029	Silicon, general purpose				D1, 3
20-2272	Carbon Film	1/2	5	2.7k	R70	22-1602	Rectifiers	100	5A		D9, 10, 11, 12, 13, 14, 15, 16
20-2330	Carbon Film	1/2	5	33	R1	22-1805	Voltage regulator	3.9V	5%		D7
20-2331	Carbon Film	1/4	5	330	R34	22-1808	Voltage regulator	5.1V	5%		D8
20-2332	Carbon Film	1/4	5	3.3k	R36, 59						
20-2471	Carbon Film	1/4	5	470	R5, 26, 28, 32						
20-2472	Carbon Film	1/4	5	4.7k	R101						
20-2561	Carbon Film	1/4	5	560	R50, 51						
20-2562	Carbon Film	1/4	5	5.6k	R62						
20-2681	Carbon Film	1/4	5	680	R7						
20-2820	Carbon Film	1/4	5	82	R18, 23, 90						
20-2821	Carbon Film	1/2	5	820	R10, 16						
20-3470	Metal Oxide	1/2	5	47	R103						
20-4013	Metal Oxide	1/4	1	8.2k	R98						
20-4094	Metal Oxide	1/4	1	6.8k	R99						
20-5055	Metal Oxide	2 1/2	5	3.9	R107						
20-2181	Carbon Film	1/4	5	180*	R40						
Resistor Arrays											
20-5503	DIL Array			13 x 10k	R78						
20-5501	DIL Array			8 x 220Ω	R81						
20-5502	DIL Array			13 x 1k	R82						
20-5500	DIL Array			7 x 56Ω	R91						

* NOTE: R40 is 'select on test'. Other values may be 150Ω, 220Ω or 270Ω.

MAIN PCB ASSEMBLY 19-0809 (Continued)

(9913)

Part No.	Description	Rat	Tol %	Value	Component Reference	Part No.	Description	Rat	Tol %	Value	Component Reference
<u>Integrated Circuits</u>						<u>Transistors</u>					
22-4044	Quad 2-Input Pos. NAND Gate (7400)				IC1	22-6009	Silicon, npn (2N4124)				Q26
22-4048	Dual-D Bistable (7474)				IC4	22-6017	Silicon, npn (2N2369)				Q8, 9, 10, 11, 12, 14, 16, 27, 31
22-4049	Decade Counter (7490)				IC14	22-6059	Silicon, npn (BFX89)				Q2, 3, 4, 5, 6, 7
22-4058	4 to 10 Line Decoder (7442)				IC17	22-6081	Silicon, npn (MJE520)				Q29
22-4059	Hex. Inverter (7404)				IC2,7	22-6101	Silicon, FET (W300A)				Q1
22-4060	Quad 2-Input NAND Gate (Open Collector) (7403)				IC5, 15	22-6113	Silicon, pnp (ZTX550)				Q15, 17, 18, 19, 20, 21, 22, 23, 24, 30
22-4061	Hex Inverter (Open Collector) (7405)				IC11						
22-4087	Quad 2 to 1 Multiplexer (74157N)				IC18	<u>Inductors</u>					
22-4128	BCD to 7 Segment Decoder (74247)				IC19	23-7016	Inductor			22 μ H	L1, L2
22-4202	Dual Freq. Comparator Op. Amp. (747)				IC10	23-7014	Inductor			10 μ H	L3
22-4505	Schottky Quad 2-Input NAND Gate (74500)				IC8	<u>Miscellaneous</u>					
22-4519	250 MHz \div 4 Counter (SP 8600B)				IC13	23-3213	IC Holder, 24 pin, for IC6				
22-4528	Triple 3-Input Line Receiver (MC 10116P)				IC12	23-8000	Ferrite Bead FX1, FX2, FX3				
22-4601	60 MHz CDI LSI (Racal)				IC6						

AMENDMENT INFORMATION

Check with Section 4 at the back of the book for latest information.

PARTS LIST: OPTION 09

LF FREQUENCY MULTIPLIER ASSEMBLY 19-0797

(Fig. 7)

Part No.	Description	Rat	Tol %	Value	Component Reference
<u>Resistors</u>					
		<u>W</u>		<u>Ω</u>	
20-2102	Carbon Film	$\frac{1}{4}$	5	1k	R7
20-2103	Carbon Film	$\frac{1}{4}$	5	10k	R6
20-2105	Carbon Film	$\frac{1}{4}$	5	1M	R4
20-2153	Carbon Film	$\frac{1}{4}$	5	15k	R2
20-2332	Carbon Film	$\frac{1}{4}$	5	3.3k	R11
20-2392	Carbon Film	$\frac{1}{4}$	5	3.9k	R8
20-2473	Carbon Film	$\frac{1}{4}$	5	47k	R1, 5, 9, 10
20-2562	Carbon Film	$\frac{1}{4}$	5	5.6k	R12
20-2564	Carbon Film	$\frac{1}{4}$	5	560k	R3
<u>Capacitors</u>					
		<u>V</u>		<u>F</u>	
21-1002	Tantalum	20	20	10 μ	C5, 6
21-1029	Tantalum	35	20	1.5 μ	C1, 2
21-1038	Tantalum	6.3	20	47 μ	C3
21-1516	Ceramic	500	10	47p	C4
21-1532	Ceramic	500	20	1n	C7
<u>Diodes</u>					
22-1029	Silicon (1N4149)				D1, 2, 3
<u>Integrated Circuits</u>					
22-4111	Operational Amplifier (741C)				IC1
22-4512	Decade Counter, low power (74L90N)				IC3, 4
22-4703	CMOS Phase-Locked Loop (CD4046AE)				IC2
<u>Transistors</u>					
22-6017	Silicon NPN (2N2369)				Q3
22-6113	Silicon PNP (ZTX 550)				Q2

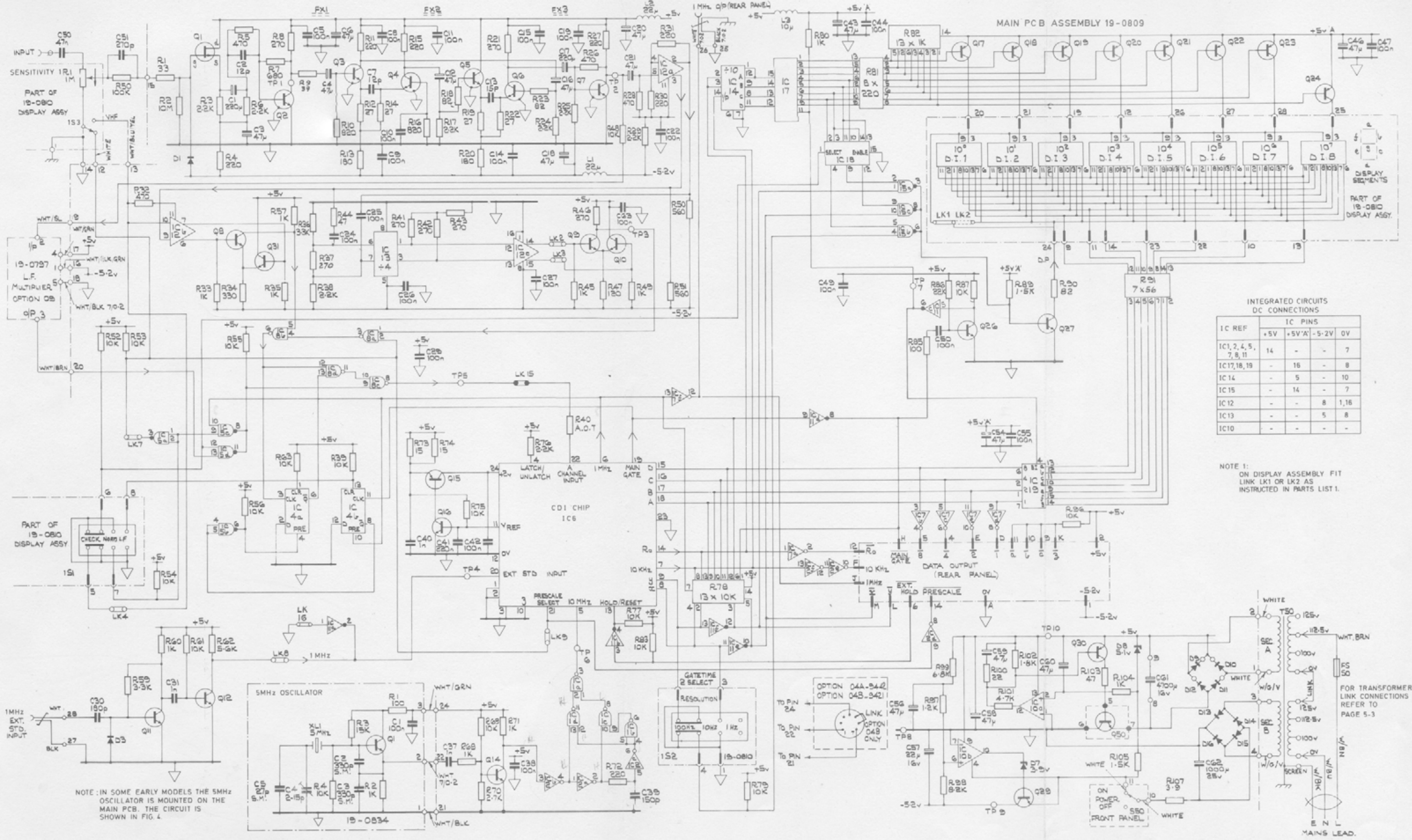

INTEGRATED CIRCUITS DC CONNECTIONS

IC REF	+5V	+5V A	-5.2V	0V
IC1, 2, 4, 5, 7, 8, 11	14	-	-	7
IC17, 18, 19	-	16	-	8
IC14	-	5	-	10
IC15	-	14	-	7
IC12	-	-	8	1, 16
IC13	-	-	5	8
IC10	-	-	-	-

NOTE 1:
ON DISPLAY ASSEMBLY FIT LINK LK1 OR LK2 AS INSTRUCTED IN PARTS LIST 1.

NOTE: IN SOME EARLY MODELS THE 5MHz OSCILLATOR IS MOUNTED ON THE MAIN PCB. THE CIRCUIT IS SHOWN IN FIG. 4

FOR TRANSFORMER LINK CONNECTIONS REFER TO PAGE 5-3

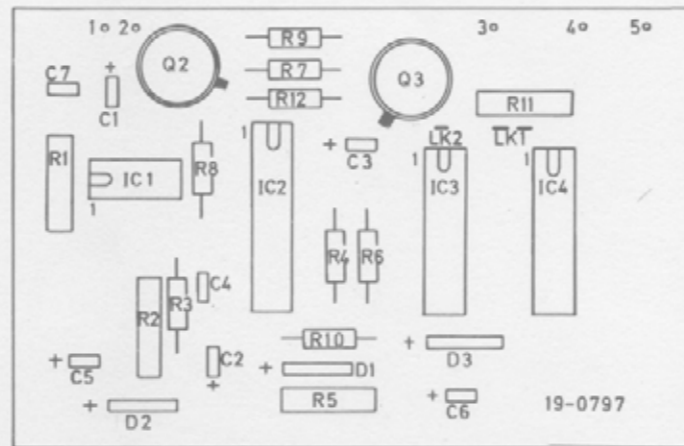
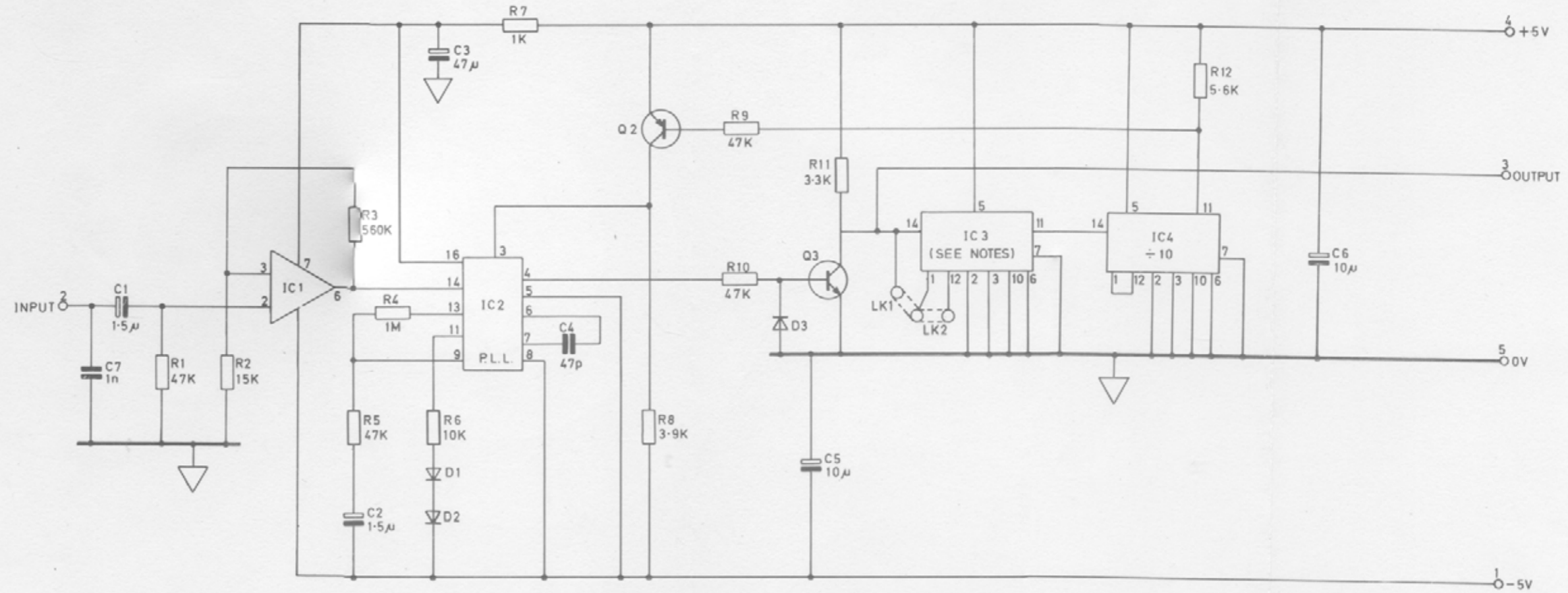

- NOTES : 1. FOR USE IN 9911 FIT LINK LK1.
DO NOT FIT LINK LK2.
2. FOR USE IN 9913 FIT LINK LK2
DO NOT FIT LINK LK1.

SECTION 4

APPENDICES

AND

CHANGE INFORMATION